

Planning Instructions

MEW01001

Revision -

Fire Alarm System EBL512 V2.5.x

Author:	Jan Pettersson	Date of issue: 2007-10-30	Date of rev:
---------	----------------	---------------------------	--------------

This page has deliberately been left blank.

Table of contents

1	Introduction	9
2	Definitions / Explanations	11
2.1	PEWF&STE AB	11
2.2	Alarm points	11
2.2.1	Smoke detector	11
2.2.2	Sensor	11
2.2.3	Analog detector	11
2.2.4	Analog (Sensor) Base (ASB)	11
2.2.5	Conventional detector	11
2.2.6	(Conventional Detector) Base (CDB)	11
2.2.7	Addressable (Detector) Base (ADB)	11
2.2.8	Addressable	12
2.2.9	Old detector	12
2.2.10	Conventional zone line input / External line	12
2.2.11	ADB input / Addressable zone interface	12
2.3	Output unit	12
2.4	Output / Control output	12
2.5	Short circuit isolator (ISO)	12
2.6	Display unit (DU)	12
2.7	COM loop	12
2.8	BS4 loop	13
2.9	Control Unit / C.U. / C.I.E.	13
2.10	Fire Brigade Panel (FBP)	13
2.11	Control panel (CP)	13
2.12	System	13
2.13	Network / TLON [®] / LonWorks [®] / Echelon / Node / TLON Conn. board / Gateway / Sub net / Backbone net / Router / Repeater	13
2.14	LED	14
2.15	External Indicator (LED)	14
2.16	Display / LCD	14
2.17	Door open (Door / Key switch)	14
2.18	Site Specific Data (SSD)	14
2.19	Software (S/W) / System program	14
3	Overview	15
3.1	The EBL512 system	15
3.1.1	Expansion boards	15
3.1.2	Printer	15
3.1.3	Power supply	15
3.2	S/W versions	16
3.3	Backwards compatibility	16
3.3.1	Upgrade the Site Specific Data (SSD)	16
3.3.2	Upgrade the EBL512 control unit (c.i.e.)	17

3.4	Documents	18
3.5	Applications	18
3.6	PC S/W	18
3.6.1	Win512	18
3.6.2	TLON Manager	19
3.6.3	NEWTEXT	19
4	Control Unit / TLON Network	20
5	Control Units 1548 – 1550	21
5.1	COM loops	23
5.2	Programmable voltage outputs (S0-S3)	25
5.3	Programmable relay outputs (R0-R1)	25
5.4	Programmable inputs (I0-I3)	25
5.5	Relay outputs for routing equipment (tx)	25
5.5.1	Fire alarm output	25
5.5.2	Fault output	26
6	Expansion boards 158x	27
6.1	Expansion board address setting	27
6.2	8 zones expansion board 1580	28
6.3	8 relays expansion board 1581	28
6.4	External Fire Brigade Panel (FBP) interface board 1582	29
6.5	German FBP interface board 1583	30
6.6	Autronica interface board 1584	30
6.7	External FBP / DU interface board 1587	32
7	Printer board 1558	33
8	TLON connection board 1590	34
9	Peripheral devices	35
9.1	COM loop units	35
9.1.1	Input units	37
9.1.2	Output units (addressable)	48
9.1.3	I / O units (addressable)	48
9.1.4	Alarm devices (addressable sounders)	50
9.1.5	Display units (addressable)	51
9.1.6	Short circuit isolator (addressable)	51
9.1.7	Other COM loop units	54
9.2	BS4 loop units	55
9.3	Units for Hazardous (Ex) areas	56
9.3.1	Addressable IS zone interface (AIS)	56
9.3.2	Galvanic isolator	56
9.3.3	Intrinsically Safe mounting base	56
9.3.4	Intrinsically Safe photoelectric smoke detector	56
9.3.5	Intrinsically Safe heat detector	57
9.4	Units connected to the Ext. FBP interface board 1582 and the Ext. FBP / DU interface board 1587	57
9.4.1	External Fire Brigade Panels	58

9.4.2	External Presentation units	61
9.4.3	Data converters	62
9.5	Alert Annunciation equipment	62
9.6	Other units	64
9.6.1	External (remote) indicators	64
9.6.2	Two inputs / one output unit 2222	65
9.6.3	Alarm devices (sounders, etc.)	65
9.6.4	Door release magnets	65
9.6.5	Boxes	65
9.6.6	Web-servers	65
10	Programmable inputs	68
10.1	Control unit Inputs I0 - I3	68
10.2	The 3361 unit's Inputs In0 / Z & In1	68
11	Input programming	69
11.1	Trigger conditions	69
11.2	Logic	72
12	Programmable outputs	73
12.1	Control unit outputs S0 – S3	74
12.2	Control unit outputs R0 – R1	74
12.3	8 relays expansion board 1581 Output 0 – Output 7	75
12.4	German FBP interface board 1583 Output for extinguishing equipment	75
12.5	The 2262 / 2263 unit's Output 0 – Output 3	75
12.6	The 2265 unit's Output 0 – Output 3	76
12.7	The 3361 unit's Output Re0 – Re1	76
12.8	The 3364 unit's VO0 – VO2	76
12.9	The 3377 unit's Output (siren)	76
12.10	The 3378 unit's Output (sounder)	76
13	Output programming	77
13.1	Type of output	77
13.2	Logic	78
13.3	Not supervised	78
13.4	Time activation	78
13.5	Control expression	80
13.5.1	Trigger conditions	80
13.5.2	Logical operators	84
13.5.3	Control expression examples	84
14	Interlocking function	88
14.1	Programming of interlocking function	88
14.1.1	Interlocking output	88
14.1.2	Interlocking input	88
14.1.3	Interlocking combination	88
14.2	Interlocking indications	90
14.3	Information of interlocking combinations (H9)	90
14.3.1	Display interlocking information (H9/C1)	90

14.3.2	Activate interlocking output (H9/C2)	91
14.3.3	Reset interlocking output (H9/C3)	91
14.3.4	Disable interlocking output (H9/C4)	91
14.3.5	Re-enable interlocking output (H9/C5)	91
14.4	Interlocking control expressions	91
15	Fire Door Closing	92
16	Functions / Services / Features	93
16.1	Sensor value	93
16.2	Week average sensor value	93
16.3	Decision value	93
16.4	Alarm algorithms for smoke detectors / Detection levels / Offsets	93
16.4.1	Alarm algorithm / Alternative alarm algorithm	94
16.4.2	Filtering algorithm	95
16.4.3	Smouldering smoke algorithm	97
16.5	Performance factor	98
16.6	Algorithms for analog heat detectors	99
16.6.1	Class A1 algorithm	100
16.6.2	Class A2 S algorithm	100
16.6.3	Class B S algorithm	100
16.7	Algorithm setting via menu H4/U5	100
16.8	Self verification	101
16.9	Minimum / Maximum sensor values	101
16.10	2-zone / 2-address dependence (co-incident alarm)	102
16.10.1	2-zone dependence	102
16.10.2	2-address (-unit) dependence	102
16.10.3	Reset of 2-zone / 2-address dependence (co-incident alarm)	103
16.11	Delayed alarm	103
16.12	Alert annunciation	103
16.13	Alarm Acknowledgement Facility (AAF)	105
16.14	Quiet alarm	107
16.15	Disable alarm points and outputs	108
16.15.1	Disable zone	108
16.15.2	Disable zone / address	108
16.15.3	Disable control output	108
16.15.4	Disable / Re-enable all control, exting. and ventilation outputs	108
16.15.5	Disable / Re-enable alarm devices	109
16.16	Disable interlocking output	109
16.17	Disable outputs for routing equipment	109
16.18	Disconnect / Re-connect loop	109
16.19	External time channels 15-63	109
16.20	Test mode	110
16.21	Test alarm devices	110

16.22	Test of routing equipment _____	110
16.23	Calibration of supervised outputs _____	110
16.24	Service signal _____	111
16.25	Analog smoke detector _____	111
16.26	Fault signal (fault condition) _____	113
16.27	User definable text messages _____	113
16.27.1	Creating the user definable text messages via Win512	113
16.27.3	Downloading texts to the DU:s 1728 / 1735 / 1736 and ext. FBP:s 1826 / 1828 _____	115
16.28	Real time clock (RTC) _____	115
16.29	Printer disable function _____	116
16.30	Loss of main power source _____	116
16.31	Win512 Tools menu _____	116
17	Redundancy in distributed system _____	118
17.1	Master and Slaves _____	118
17.1.1	Master unit _____	118
17.1.2	Slave unit _____	119
17.2	Several control units _____	121
17.2.1	Master unit _____	121
17.2.2	Several control units (slaves) _____	121
18	Cyber sensor functions _____	125
18.1	Pulse up – down counter _____	126
18.1.1	Pulse up – down counter for smoke _____	126
18.1.2	Pulse up – down counter for temperature _____	126
18.1.3	Pulse up – down counter for smoke & temperature _____	126
18.2	Fire judgement _____	126
18.3	Alarm threshold levels _____	127
18.4	Learning function / Learning conditions _____	127
18.4.1	Learning conditions _____	128
18.5	Alarm delay time _____	129
18.6	Analog data output _____	130
18.7	Sensitivity compensation _____	131
18.8	Self diagnosis of internal devices _____	131
18.10	Address setting check _____	131
19	Control unit properties (settings) _____	132
19.1	Control unit data _____	132
19.1.1	General data _____	132
19.1.2	LED indications by inputs _____	132
19.1.3	Miscellaneous _____	133
19.1.4	Selective alarm presentation _____	133
19.2	Log events _____	134
19.3	Log setup _____	135
19.3.1	General event log _____	135
19.3.2	Sensor log _____	135
19.3.3	Communication error log _____	136

19.4	Control unit information _____	136
20	System properties (settings) _____	137
20.1	System data _____	137
20.1.1	Logical name _____	137
20.1.2	Alarm delay time _____	137
20.1.3	Main power loss fault delay time _____	137
20.1.4	Alarm reset _____	137
20.1.5	Door closing by time _____	138
20.1.6	Miscellaneous _____	138
20.1.7	LCD in quiescent state _____	139
20.2	Time channels _____	139
20.3	Time activation output _____	140
20.4	Door open _____	140
20.4.1	Indication door open affected by _____	140
20.4.2	Disablement of routing equipment _____	141
20.5	National holidays _____	141
20.6	Alarm algorithms _____	142
20.6.1	Classic smoke detectors' properties _____	142
20.6.2	Heat detectors' (3308, 3309, 3316 and 4300) properties	142
20.6.3	Smoke detectors' (3304, 4301, 3316 and 4300) properties	143
20.6.4	Multi detectors' (3316 and 4300 + decision algorithm) properties	144
20.7	System information _____	144
20.8	Alert Annunciation and Alarm Acknowledgement Facility	144
20.8.1	Alert Annunciation _____	144
20.8.2	Alarm Acknowledgement Facility _____	145
20.9	Two zone dependence _____	145
21	Compatibility _____	146
22	Cable types _____	147
22.1	TLON Network cables _____	147
22.2	COM loop cables _____	147
22.3	BS4 loop cables _____	147
22.4	Ext. FBP / Data converter cables _____	147
22.5	Conventional zone line cables _____	148
22.6	Alarm device cables _____	148
22.7	Other cables _____	148
23	COM loop cable length _____	149
24	Current consumption _____	152
25	Power supply _____	157
25.1	Charger functions _____	158
25.1.1	Low and High current charging modes _____	158
25.1.2	Battery charging functions: _____	158
25.1.3	Security functions: _____	159

25.2	Current consumption calculations _____	159
25.3	Rectifier (main power source) _____	160
25.4	Battery (second power source) _____	160
25.5	Fuses _____	161
25.6	Form / Table of current consumption _____	162
26	S/W versions _____	163
27	Technical data _____	164
28	Limitations _____	165
28.1	User definable texts _____	165
28.2	C.i.e. / System _____	165
29	National regulations _____	167
30	Drawings / connection diagrams _____	168
31	Revision history _____	169

Drawings according to the valid table of drawings.

1 Introduction

EBL512 Planning Instructions is a document¹ intended to be used by planning engineers as well as service / commissioning engineers.

This document should be read in conjunction with the drawings according to the valid Table of drawings and the EBL512 Operating Instructions.

When planning a fire alarm installation the national regulations have to be obeyed. A lot of detector types can be used. Detector coverage area and detector placing in the room / building, etc. are matters for the planning engineers and are not described in this document.

Due to continual development and improvement, different S/W versions might be found. This document is valid for **S/W version 2.5.x**. On the date / revision date of the document $x = 0$.

Since the EBL512 control unit (c.i.e.) is produced for many countries the look, the texts, the functions, etc. might vary.

Products

Consists of one or more parts (HW) according to a **Product Parts List**. A product has:

- a **type number** (e.g. **1548**)
- an **article number**, often = the type no. and sometimes is a country code added (e.g. **1548SE**)
- a **product name** (e.g. **EBL512 control unit, 128 addresses, without printer**)

HW

A HW (e.g. a **printed circuit board**) has:

- a **type number** (e.g. **1556**)
- an **article number**, often = the type no. and sometimes is a country code added (e.g. **1556SE**)
- a **product name** (e.g. **Main Board 128 addr.**)
- a **p.c.b. number** (e.g. **9261-3A**) and can also have a configuration (e.g. **CFG: 1**) and a revision (e.g. **REV: 2**)
- sometimes a **S/W**

S/W

A S/W has:

- a **version number** (e.g. **V2.5.x**)

¹ File name: K:\PRO\FIRE\512\Doc\2.5.x\MEW01001 (Rev -).doc

- sometimes additional information, such as **Convention** (different functions / facilities), **Language**, **Number of addresses**, etc.

PC S/W

A PC S/W is a program used for programming, commissioning, etc. It has a **version number**.

2 Definitions / Explanations

Definitions / explanations / abbreviations / etc. frequently used or not explained elsewhere in the document.

2.1 PEWF&STE AB

Panasonic Electric Works Fire & Security Technology Europe AB

2.2 Alarm points

Units, which can generate a fire alarm (in the control unit), i.e. analog detectors (sensors), conventional detectors, manual call points, etc.

2.2.1 Smoke detector

Analog and conventional photoelectric (optical) smoke detectors are available.

2.2.2 Sensor

Sensor = Analog detector

2.2.3 Analog detector

Contains an A/D-converter. The Control Unit pick up the digital values ("sensor values") for each detector individually. All evaluations and "decisions" are then made in the c.i.e. Analog detectors are addressable – an address setting tool is used for detector types **33xx** / **430x**. Old installations: A DIL-switch in the **ASB** (see below) is used for address setting for detectors **2xxx**.

An analog detector has to be plugged in an analog sensor base (**ASB**).

2.2.4 Analog (Sensor) Base (ASB)

A sensor is plugged in an ASB, which is connected to a COM loop (see below). Old installations: Analog sensor base types **2xxx** have a DIL-switch for the COM loop address setting.

2.2.5 Conventional detector

Detector with only two statuses, i.e. normal and fire alarm. The detector contains a closing contact and a series alarm resistor. Normally plugged in a conventional detector base **CDB** (see below) connected to a conventional zone line input, with an end-of-line device. Some types are connected directly on zone line. Old installations: An addressable detector base (ADB) for conventional detectors (see below) could be connected directly to a COM loop.

2.2.6 (Conventional Detector) Base (CDB)

A conventional detector is plugged in a CDB, connected to a conventional zone line input.

2.2.7 Addressable (Detector) Base (ADB)

Old installations: An ADB for conventional detectors (see above) could be connected directly to a COM loop.

- 2.2.8 Addressable**
A unit with a built-in address device, i.e. each unit is individually identified, handled and indicated in the c.i.e.

(The unit can be an I/O unit with a zone line input, to which one or more conventional "alarm points" can be connected.)
- 2.2.9 Old detector**
Old installations: Conventional detector with a closing contact (i.e. a short circuit; no alarm resistor), or a detector with two breaking contacts.
- 2.2.10 Conventional zone line input / External line**
Input intended for one or more conventional alarm points. End-of-line device in the last alarm point.

Old installations: ADB / Addressable zone interface input, intended for one or more conventional alarm points. End-of-line resistor in the last alarm point.
- 2.2.11 ADB input / Addressable zone interface**
Old installations: Ext. line / conventional zone line, intended for one or more conventional alarm points. End-of-line resistor in the last alarm point.
- 2.3 Output unit**
Addressable unit with programmable control outputs. Connected to a COM loop (see below).
- 2.4 Output / Control output**
Defined or programmable function. Relay output or voltage output (supervised / monitored), in the c.i.e. or an output unit.
- 2.5 Short circuit isolator (ISO)**
Addressable unit for automatic disconnection of a part (segment) of a COM loop (see below) in case of a short circuit on the loop. (According to EN54-2: One ISO is required per 32 alarm points on the COM loop.)
- 2.6 Display unit (DU)**
Addressable unit for fire alarm presentation (incl. user definable text messages, if programmed).
- 2.7 COM loop**
Loop = a cable, with two wires, to which all the addressable units can be connected. Starts in the c.i.e. and it returns back to the c.i.e.
-

2.8 BS4 loop

Loop = a cable, with two wires, to which all the addressable Autronica (BS100) units can be connected. Starts in the c.i.e. and it returns back to the c.i.e.

2.9 Control Unit / C.U. / C.I.E.

Control Unit = Control and Indicating Equipment = Unit to which the alarm points are connected (via a COM loop). Indicates fire alarm, fault condition, etc. Fire Brigade Panel & Control Panel (see below) included or not included. Printer included or not included.

2.10 Fire Brigade Panel (FBP)

Unit intended for fire alarm presentation, etc. for the fire brigade personnel. Can be a part of the control unit (front) or a separate unit (external FBP).

In the ext. FBP, a printer can be included or not included.

2.11 Control panel (CP)

A part of the control unit (front), intended for the building occupier, service personnel, etc., to "communicate" with the control unit / system.

2.12 System

Several control units connected via a TLON network (co-operating control units).

2.13 Network / TLON[®] / LonWorks[®] / Echelon / Node / TLON Conn. board / Gateway / Sub net / Backbone net / Router / Repeater

Brief explanations to the words/expressions to be found in connection with a "network". See also separate TLON Technical description.

TLON[®] = TeleLarm Local Operating Network = a LonWorks[®]- based network² for communication between several units/nodes. The protocol is LonTalk and the transmission works with doubly-terminated bus topology (Echelon FTT-10). To connect a control unit to the network, a TLON connection board is plugged in the control unit. (Old installations: Some control units, not prepared for network connection, could be connected via a serial interface and a Gateway).

A network can be one sub net (FTT-10) or several sub nets, connected via routers. (In the TLON Network a sub net = a channel.)

² LonWorks[®] = A "summing-up-name" for the market of Echelon Corporation Inc. technology.

Repeaters are used to increase the maximum cable length, node to node, in a network.

Router or Repeater is the same type of unit (different configuration). All network programming (configuration) are made with the PC program "TLON Manager".

2.14 LED

LED (**L**ight **E**mitting **D**iode) = Yellow, green or red optical indicator ("lamp").

2.15 External Indicator (LED)

A unit with an LED. Connected to an ASB, CDB or a detector with a built-in LED. Old installations: Also connected to an ADB.

Lit when the built-in LED is lit.

2.16 Display / LCD

LCD (**L**iquid **C**rystal **D**isplay) = Display (in the c.i.e. or Display unit) for presentation of fire alarms, fault messages, etc. Normally 40 alphanumeric characters and backlight.

2.17 Door open (Door / Key switch)

In EBL512 there is a door switch, which is activated when the control unit door is open. In some other units this door switch is replaced with a key switch.

The LED "Door open" is indicating "door open" / key switch in position "open".

2.18 Site Specific Data (SSD)

The SSD is unique for each installation. All alarm points, presentation numbers, user definable text messages, programmable outputs, etc. are created in the PC program **Win512** and also downloaded in EBL512 with **Win512**.

2.19 Software (S/W) / System program

The S/W makes the control unit (the microprocessor) work. It is factory downloaded but a new version can be downloaded in EBL512 on site.

3 Overview

3.1 The EBL512 system

EBL512 is a microprocessor controlled intelligent fire alarm system, intended for analog addressable smoke detectors, as well as conventional detectors and manual call points. Programmable control outputs and output units are available. Up to 512 addresses can be connected to each control unit (c.i.e.).

EBL512 is available in several types, versions and configurations. It can be connected to a TLON network, a "system", with up to 30 control units. Each control unit has total access to all information.

EBL512 is designed according to the European standards EN 54, part 2 and 4.

3.1.1 Expansion boards

In the control unit (c.i.e.) it is possible to mount up to six expansion boards. The following types are available (see also chapter "Expansion boards 158x", page 27):

1580 8 zones expansion board

1581 8 relays expansion board

1582 External FBP interface board³

1583 German FBP interface board⁴

1584 Autronica interface board (four BS4 loops)⁵

1587 External FBP / DU interface board³

3.1.2 Printer

Control unit 1549 is equipped with a printer.

In control unit 1548 it is possible to mount a printer 1558.

3.1.3 Power supply

The main power source is a built-in rectifier (1537), 230 V AC / 24 V DC, 4.5 A.

The second power source is a backup battery (2 x 12 V). In the c.i.e. is space for two 24-27 Ah batteries. Larger batteries (up to 60 Ah) has to be placed outside the c.i.e.

³ Max. two 1582 + 1587 boards (together) per control unit.

1582 is replaced by 1587.

⁴ Max. one 1583 board per control unit. 1583 board is **not** possible to use in Swedish (SBF) convention.

⁵ Max. four 1584 boards per control unit. 1584 boards are normally used in Swedish (SBF) convention only.

The batteries and the rectifier are connected to the Charger board (1657), which handles the charging of the batteries, etc. Low or High current charging mode has to be selected depending on the wanted battery capacity⁶ and/or the EBL512 current consumption. See chapter "Power supply", page 157 for more information.

3.2 S/W versions

Due to continual development and improvement, different S/W versions can be found. When installing a new control unit in a system with "older" control units, you might have to update the S/W in the old control units. It is **highly recommended** to have the same S/W version in all control units but **S/W version \geq 2.X.x require the same S/W version in all control units.**

3.3 Backwards compatibility

	EBL512 software version 1.xx	EBL512 software version \geq 2.0.x ⁷
Front Type 1 (original)	OK	OK
Front Type 2 (EN54)	Not OK	OK

NOTE!

In S/W version 1.xx, a printer could be connected to the External FBP interface board 1582. This option is deleted in S/W version \geq 2.0.x. Required actions have to be taken.

In PLAN512 / PROJ512, the offset values for pre-warning and heavy smoke alarm are "Control unit settings". In Win512, the corresponding settings (offset pre-warning & offset heavy smoke) are "System properties". Check the values and edit when required.

3.3.1 Upgrade the Site Specific Data (SSD)

EBL512 S/W version 2.X.x require SSD downloaded via Win512 version 2.X.x. (Always use the corresponding Win512 version. The first two digits have to be the same in the EBL and Win version respectively, e.g. 2.5.x.)

1a) SSD made in earlier versions of **Win512** (i.e. **V1.XX.x**) can be used. Open the file in Win512 V2.X.x (File | Open...). In order, not to lose the old file, save the file (File | Save As...) with a new name or in another directory.

1b) SSD made in **PLAN512 / PROJ512** version **1.15** (only) can be used. Open the file in Win512 V2.1.x (File | Import Old File...). Save the file (File | Save As...) with a new name (and in another directory).

⁶ Depending on the required battery backup time (e.g. 30 or 72 hours).

⁷ Main board 1556 with two flash memories is required. These p.c.b.:s are marked 9261-3A / **CFG 5** / REV 1, 9261-3A / **CFG 5** / REV 2, 9261-5C / **CFG 5** / REV 1 or 9261-5A / **CFG 5** / REV 1.

2) Start an SSD validation (Win512 menu Tools | Validate). Correct any "System errors", "Warnings" or "Convention violations (EN54)" found.

3) If there are detectors type 3304 (in 2312 mode) and type 3308 (in 2330 mode) in the installation, they can be upgraded to NORMAL mode⁸. See chapter "Analog Detectors", page 40 and Win512 help, chapter "Upgrade Loop Units". See also the following chapter.

NOTE! It is not possible to do the contrary (i.e. to downgrade). Double check before upgrading. Only 3304 and 3308 units can be upgraded.

4) Save the SSD after required editing. Regarding the SSD download, see the following chapter.

3.3.2 Upgrade the EBL512 control unit (c.i.e.)

1) When required, change front Type 1 (original) to Type 2 (EN54).

2) The new software (S/W version 2.X.x) shall now be downloaded (Win512: Tools | Download Software...)⁹. See also Win512 help, chapter "Download Software".

NOTE! Before ending the "bootstrap mode" and restart, continue to the following paragraph.

3) Read the "old" EBL512 settings (Win512: Tools | EBL512 Settings...). When required, change the settings, e.g. "Adhesive type" from Type 1 (original) to Type 2 (EN54). Download the settings. See also Win512 help, chapter "EBL512 Settings".

Except the normal fault message after the control unit restart and supervised output faults, the following fault message will be displayed (since the new SSD has not yet been downloaded in the control unit):

FAULT: Site specific data (SSD), CU ## Date: MM-DD Time: HH:MM

4) The new Site Specific Data (SSD), saved in Win512 version 2.X.x, shall now be downloaded (Win512: Tools | Download). See also Win512 help, chapter "Download".

NOTE! If 3304 and 3308 detectors have been upgraded to NORMAL mode in Win512 (see the chapter above), the detectors in the installation will now be automatically upgraded (via the COM loop) before the SSD will be downloaded¹⁰. Each detector upgraded will be displayed in the Win512 log view¹¹.

⁸ Not valid for 3304 detectors with Serial No. 7000001 – 7004527. These detectors must only be used in 2312 and 2330 mode respectively.

⁹ If a message shows that also a language file download is required, do so.

¹⁰ This is only valid the very first time the new SSD is downloaded.

¹¹ If Win512 failed to upgrade a detector, try to set the NORMAL mode via the address setting tool 3314. **NOTE!** Not valid for 3304 detectors with

After the download, the control unit will restart and except the normal fault message after the restart, the following fault message will be displayed:

FAULT: Read/write site data (SSW), CU ## Date: MM-DD Time: HH:MM

This fault will be automatically corrected within a few minutes. All faults in the system have to be acknowledged.

NOTE! The SSW will be erased / set to default as follows:

Sensor week average values will be erased and new values will be calculated within two minutes after restart. Passwords will be set to default. All logs will be erased. Supervised outputs calibration will be reset (i.e. calibration has to be performed via menu H5/A1).

3.4 Documents

The following documents are available:

- Planning instructions
- Drawings
- Operating instructions

Normally information that is found in one document is not to be found in another document, i.e. the documents complement each other.

3.5 Applications

The EBL512 system is intended for small, medium and large installations. The intelligent control units offer the system designer and end user a technically sophisticated range of facilities and functions. Programming (PC S/W Win512) and commissioning of the control unit / system is very easy. Start with one control unit and then, when required, add more units. The TLON network makes it possible to install the control units in one building or in many buildings.

3.6 PC S/W

A number of PC S/Ws are used together with the EBL512 system.

3.6.1 Win512

Win512 is used for programming and commissioning of one or more control units:

- download / backup of site specific data (SSD)
- download of S/W / settings / conventions / configurations / C.U. & system data / etc.

Serial No. 7000001 – 7004527. These detectors must only be used in 2312 and 2330 mode respectively.

- create and download the user definable text messages shown in the alphanumeric display in the C.U. / ext. FBP and in the Display units.

Win512 shall have the same (or higher) version number as the EBL512 S/W version number (e.g. **2.5.x** and **2.5.x** respectively). Backup require the same version number (in Win512 and EBL512). Old files can be opened and saved in a higher version of Win512 and thereafter downloaded.

3.6.2 TLON Manager

TLON Manager is used for programming of network data / addresses / etc.

3.6.3 NEWTEXT

NEWTEXT (DOS based "older" program) can be used to create / download the user definable text messages in the display units connected to the COM loops.

4 Control Unit / TLON Network

An installation (system) can be **one control unit (c.i.e.)** or up to 30 control units in a **TLON network**.

In a TLON network each control unit works independent but has nevertheless total access to all information in the system.

NOTE!

In a system (two or more control units in a TLON network), pay attention to the following:

- The alarm points and their "belonging" outputs should normally, for safety reasons, be connected to the same control unit.
- When the "Fire door closing" function is used, the alarm points and their "belonging" output must be connected to the same c.i.e.
- As from **V2.0**, a zone **must not be distributed over the system**, i.e. all alarm points in a zone have to be connected to one c.i.e.
- When the interlocking function is used, the input, the output and the area in the Interlocking Combination must be in / connected to one c.i.e. The input and the output can only be used in one combination.

NOTE!

For highest security the function **Redundancy in distributed system** can be used in a system with a TLON Network. One control unit is a "master" unit and the other control units in the system are "slave" units that are connected to the "master" unit via a separate network and a 1580 board¹² in the "master" unit.

For more information see chapter "Redundancy in distributed system", page 118.

¹² As an alternative the I/O unit 3361 zone line input can be used.

5 Control Units 1548 – 1550

Three types of control units are available:

Type no.	Product	Front (FBP & CP)	Printer (1558)
1548	EBL512 Control unit ¹³ . No expansion boards.	Yes	No ¹⁴
1549	EBL512 Control unit ¹³ . No expansion boards.	Yes	Yes
1550	EBL512 Control unit ¹³ . No expansion boards.	No ¹⁵	No



Figure 1. The EBL512 Control Unit (1548 / 1549). The look might vary according to configuration, etc.

¹³ Basic configuration can be 128, 256 or 512 addressable loop units.

¹⁴ Prepared with space & connectors for printer board 1558, i.e. the printer board 1558 can afterwards be mounted in control unit 1548.

¹⁵ The built-in buzzer is always disabled.

The control unit is housed in a grey metal cabinet. Depending on country, convention, configuration, etc. the look, language and functions might vary, as well as the max. number of loop units (addresses).

The door in 1548 & 1549 has a Plexiglas ahead of the **Fire Brigade Panel (FBP)**, see Figure 1. When the door is open, you can fully see the front, i.e. the **FBP**, and the **Control Panel (CP)**, see Figure 2.

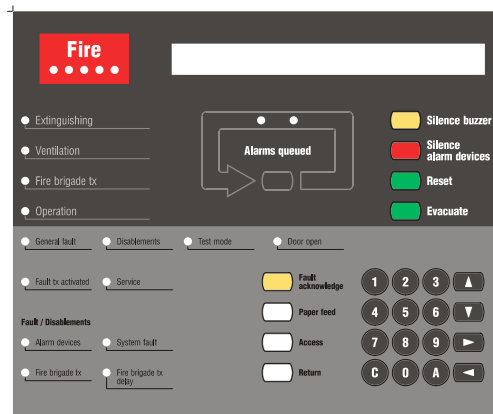

Figure 2. The EBL512 front; FBP (upper black part) and CP (lower grey part). The look might vary according to country, language, convention and configuration. (An English front is shown in the figure).

The fire brigade personnel use the FBP to see which alarm point / zone(s) having generated fire alarm. In the display (LCD, 2x40 alphanumeric characters), the information displayed on the first row is depending on how many alarm points / zones having generated fire alarm (and also convention). On the second row is, for an alarm point or a zone, a user definable text message shown, if programmed.

Required fire brigade personnel manoeuvres can be performed from the FBP.

External FBPs are available.

The CP is used to "communicate" with the system¹⁶, e.g. for commissioning, monthly tests or maintenance. Access codes for different access levels are required. A keypad is used to get access to the system (a menu tree with main and sub menus) and for different manoeuvres. The CP has several system status LEDs.

NOTE! Regarding LED indicators, keypad / push buttons, access levels and for more information, see EBL512 Operating Instructions, V2.5.x.

¹⁶ I.e. a man-machine interface.

Each control unit 1548-1550 has the following basic configuration:

- Grey metal cabinet
- EBL512 front (not in 1550)
- Main board 1556
 - Space & connectors for TLON connection board 1590
- Printer 1558 (only in 1549)
- Connection board 1555
 - Four COM loops (0-3) to which the loop units are connected.
 - Four programmable supervised voltage outputs (S0-S3).
 - Two programmable relay outputs (R0-R1).
 - Four programmable inputs (I0-I3).
 - Two 24 V DC outputs (power supply of routing equipment and external equipment respectively). Connections and more information, see dwg. 512-44.
 - Two not programmable relay outputs for routing equipment (Fire brigade tx and Fault tx respectively). Connections and more information, see dwg. 512-44.
- Built-in power supply. See chapter "Power supply", page 157. Connections and more information, see dwg. 512-32.
 - Charger board 1657¹⁷ (**Low** or **High current charging mode** can be selected.)
 - Rectifier 1537
 - Space for two Sealed Lead-Acid backup batteries (12 V, 24-27 Ah)
- Space (and connector on the connection board 1555) for up to six expansion boards 158x.

See following chapters for more / detailed information.

5.1 COM loops

Each control unit has four COM loops (0-3) to which the loop units are connected.

Connections according to dwg 512-41, -51 - -55 and -61 - -62.

On each COM loop can up to 127 COM loop units be connected. Regarding the types and number of COM loop units in relation to the cable length / type, see dwg 512-01 and -02.

¹⁷ The Charger board 1557 has been replaced by 1657.

Each COM loop unit has a technical number and each alarm point and zone line input has a presentation number. See EBL512 Operating Instructions for more information.

Break or short circuit on a COM loop

Normally the control unit communicates with the units in one direction, which is automatically changed every 60 second.

I.e. a break on a COM loop, between "the last unit" and the control unit, will generate a fault within 60-100 seconds (EN54 requirement).

By a single break on a loop, between the control unit and the last unit, the following will happen:

- The communication starts in both directions.
- Since it is a single break all units will now be "found" by the control unit. A fault is generated and a fault message is shown:
FAULT: Cut-off COM-loop x, CU x
- Each 10th minute is an attempt made to communicate in one direction again. When the break is repaired the communication in one direction starts again.
- Regarding Fault acknowledge, see EBL512 Operating Instructions.

By two or more breaks on a loop, between the control unit and the last unit, the following will happen:

- The communication starts in both directions.
- Since it is not a single break all units will not be "found" by the control unit. A fault is generated for each unit not found and fault messages are shown:
FAULT: No reply techn. no. xxxxxx
- Each 10th minute is an attempt made to communicate in one direction again. When the breaks are repaired the communication in one direction starts again.
- Regarding Fault acknowledge see EBL512 Operating Instructions.

By a short circuit on a loop, the following will happen:

- The communication stops. The loop is disabled.
- A fault is generated and a fault message is shown:
FAULT: Short-circuit COM-loop x, CU xx
- Each 10th minute is an attempt made to re-enable the loop. When the short circuit is repaired the communication starts again.
- Regarding Fault acknowledge, see EBL512 Operating Instructions.

NOTE! If one or more addressable short circuit isolators are used, the loop will be divided into "segments" (the part between two short circuit isolators or between the control unit and one short circuit isolator). Only the affected segment will be isolated, which will minimise the number of units disabled by a short circuit.

5.2 Programmable voltage outputs (S0-S3)

These 24 V DC outputs are supervised (monitored)¹⁸. Connections according to dwg 512-42. When the connections are done, a calibration has to be performed. See chapter "Calibration of supervised outputs", page 110 and EBL512 Operating Instructions chapter "Calibration of supervised outputs (menu H5/A1)".

Each output has to be programmed (Win512) regarding:

- Type
- Logic, i.e. normally low (default) **or** normally high (24 V DC)¹⁹.
- Activation time and type (steady, pulse delay, etc.)
- Control expression

See also Win512 help and chapter "Programmable outputs", page 73.

5.3 Programmable relay outputs (R0-R1)

Connections according to dwg 512-42.

Each output has to be programmed (Win512) regarding:

- Type
- Logic, i.e. normally open (NO) **or** normally closed (NC) contacts
- Activation time and type (steady, pulse delay, etc.)
- Control expression

See also Win512 help and chapter "Programmable outputs", page 73.

5.4 Programmable inputs (I0-I3)

Connections according to dwg 512-43.

Each input has to be programmed (Win512) regarding:

- Trigger condition (Triggered by)
- Logic, i.e. normally open (NO) **or** normally closed (NC) contacts
- Additional information when required: Fault no., Zone, Address and Fault message (Error text)

See also Win512 help and chapter "Programmable inputs", page 68.

5.5 Relay outputs for routing equipment (tx)

Not programmable outputs. The outputs can be tested via menu H1, see Operating Instructions.

5.5.1 Fire alarm output

This output is normally used for routing equipment (Fire brigade tx). It is a change-over relay contact that will be activated when a fire

¹⁸ This is default, but via Win512 it is possible to set each output (S0-S3) individually to be not supervised.

¹⁹ A normally high output is not supervised.

alarm is generated in the control unit (c.i.e.)²⁰. Activated output is (normally) indicated by the LED "Fire brigade tx".²¹

5.5.2 Fault output

This output is normally used for routing equipment (Fault tx). It is a change-over relay contact that is normally activated and will be de-activated when a fault is generated²² in the control unit (c.i.e.)²³.

De-activated output (i.e. fault condition) is indicated by the LED "Fault tx activated".

²⁰ The output will not be activated if it is disabled via "door open" or via menu H8/S1. See also chapter "Alert annunciation", page 103.

²¹ This output and programmable outputs with type of output 4 = Routing equipment, will normally turn on the LED but it is possible to use a programmable input with trigger condition 8 = Activated routing equipment, to turn on the LED instead.

²² Also when there is no power supply (e.g. rectifier and battery out of work) and Watch-dog fault.

²³ The output will not be de-activated if it is disabled via "door open" or via menu H8/S1.

6 Expansion boards 158x

In each control unit can be mounted up to six expansion boards. See drawings 512-15 & -16.

- Board no. **one** is connected directly to the connection board SBUS connector J5 ("D" type).
- Between board no. one and **two**, a connection cable 1585 (male/male) is required.
- Board no. **three** is connected directly to board no. two.
- Between board no. three and **four**, a connection cable 1586 (female / female) is required.
- Board no. **five** is connected directly to board no. four.
- Between board no. five and **six**, a connection cable 1585 (male/male) is required.

Win512 is used for the expansion board programming. For more information see the Win512 help.

6.1 Expansion board address setting

On each board there are address setting jumpers. For **each type** of board, an address has to be set.

1580: BY1-BY3

1581: BY1-BY3

1582²⁴: BY1 (regarding BY4, see description below)

1583: - (BY1-BY3 must not be used for address setting)

1584: BY1-BY2 (BY3 must not be used for address setting)

1587²⁴: BY1

Each type of board	Board no.	BY1	BY2	BY3
First board	0			
Second board	1	X		
Third board	2		X	
Fourth board	3	X	X	
Fifth board	4			X
Sixth board	5	X		X

X = Jumper set (shunted).

(E.g. if only one board of each type is used, each type of board is number 0, i.e. no jumpers shall be set.)

Figure 3. Expansion boards 1580–1587. Address setting table.

²⁴ 1582 is replaced with 1587.

6.2 8 zones expansion board 1580

Up to **six** 1580 boards can be used.²⁵

Each board has to be programmed (Win512) regarding:

- Address (that is set with jumpers on the board)

This board has eight inputs for conventional zone lines (i.e. for conventional detectors). In the last unit on each zone line an end-of-line resistor (4K7) has to be connected.

The 1580 zone line inputs can, as an alternative, be used for a single "slave" unit (control unit) or several control units connected in parallel, see chapter "Redundancy in distributed system", page 118.

Connections according to dwg 512-46.

Each zone line input has to be programmed (Win512) regarding:

- Type of detectors (default 0 = Not used)
 1. Conventional detectors
 2. Alarm on short circuit (conventional detectors but a short circuit on the line will generate a fire alarm instead of a fault)
 3. Alarm from CU (a single "slave" unit or several control units connected in parallel)
- Zone number (plus address within the zone when required)
alt. Control unit number for a "slave" alt. Several control units
- User definable text message (when required)
- Alert annunciation, steady ON or ON/OFF via a time channel
- Disablement via a time channel
- Fire alarm delay
- Two unit (2-zone) dependent fire alarm (set in the Win512 System dialog box)

Depending on the selected type, one or more options might be disabled.

6.3 8 relays expansion board 1581

Up to **six** 1581 boards can be used.²⁵

Each board has to be programmed (Win512) regarding:

²⁵ **NOTE!** In each control unit can, in total, up to six expansion boards be mounted.

- Address (that is set with jumpers on the board)

This board has eight programmable relay outputs (0-7).

Connections according to dwg 512-47.

Each output has to be programmed (Win512) regarding:

- Type
- Logic, i.e. normally open (NO) **or** normally closed (NC) contacts
- Activation time and type (steady, pulse delay, etc.)
- Control expression

For more information, see Win512 help or chapter "Programmable outputs", page 73.

6.4 External Fire Brigade Panel (FBP) interface board 1582

Up to **two** 1582 boards can be used.^{25 26}

(The 1582 board is now replaced with the 1587 board, see page 32.)

Each board has to be programmed (Win512) regarding:

- Number of ext. FBPs or data converters (connected to board)
- Address (that is set with jumpers on the board)

This board has an interface for up to eight external FBPs (or data converters)²⁷. Data rate 1200 baud.

All **fire alarm** information (i.e. no pre-warnings and no heavy smoke alarms) shown in the c.i.e. will also be shown in the ext. FBP(s).

NOTE! Only the ten first fire alarms will be sent out to the ext. FBPs / Data converters. When **only Data converters** are connected to a 1582 board, jumper BY4 on that board can be set (shunted), in order to send out all fire alarms to the Data converters.

Connections according to dwg 512-47.

²⁶ **NOTE!** Because of high components on the board, a 1582 board always has to be mounted "on top". This is also valid for the 1587 board, i.e. 1582 + 1587 \leq two boards. When no other boards are used, only one 1582 / 1587 board can be used. **As from February 2005, eight spacer bolts are supplied with each 1582 / 1587 board, which makes it possible to mount these two boards in any expansion board position in the control unit.**

²⁷ Ext. FBP incl. printer has a high current requirement. See chapt. "Current consumption", page 152 for more information. Regarding ext. FBPs and Data converters see also chapter "Other units", page 64.

6.5 German FBP interface board 1583

Only **one** 1583 board²⁸ can be used.²⁵ (Only address "0" can be used, i.e. no address programming. BY1-3 must not be used for address setting on this board). This board has:

- Inputs and outputs for one German FBP (Feuerwehr Bedienfeld).
- One input and one output (VdS Standard-Schnittstelle "Löschen") for one German extinguishing equipment.

Connections according to dwg 512-50.

The output "Löschen" has to be programmed (Win512) regarding:

- Activation (Time Activation Output x; Output type 0=steady only), see chapter "Time activation", page 78.
- Control expression (For more information, see Win512 help or chapter "Programmable outputs", page 73.)

6.6 Autronica interface board 1584

Up to **four** 1584 boards can be used.²⁵ (BY3 must not be used for address setting on this board).

Each board has to be programmed (Win512) regarding:

- Address (that is set with jumpers on the board)

Each board has four BS4 loops (0-3) for Autronica (BS-100) loop units.

On each BS4 loop up to 99 BS4 loop units can be connected. Regarding the BS4 loop units, see separate Autronica documents.

Each BS4 loop unit has a technical number and each alarm point and zone line input has a presentation number. See EBL512 Operating Instructions for more information.

Each BS4 loop unit is to be programmed (Win512) regarding:

- Zone number and Address within the zone
- Logical Name (normally not changed)
- Two unit (2-zone/address) dependent fire alarm (some units only)
- Fire alarm delay (some units only)
- Alert annunciation, steady ON or ON/OFF via a time channel (some units only)
- Disablement via a time channel (some units only)
- User definable text message (when required)

²⁸ Can not be used in Swedish (SBF) convention.

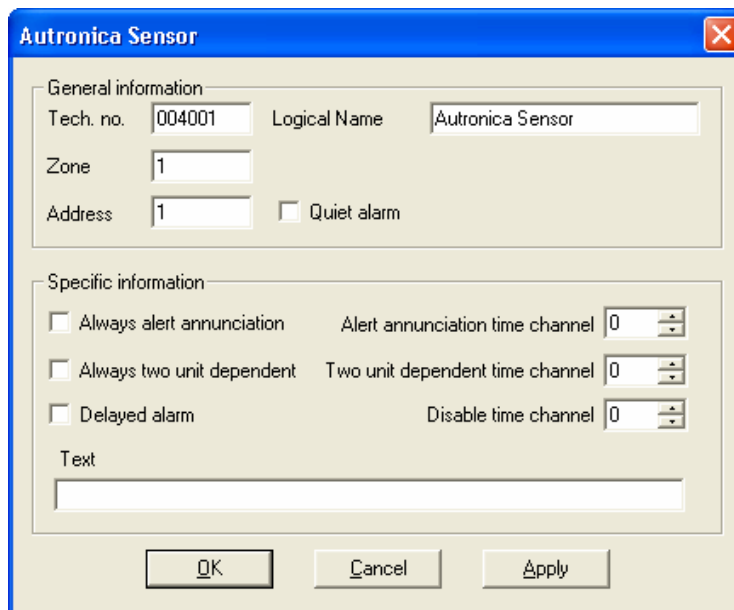

Figure 4. Win512 "Autronica Sensor" dialog box.

For more information see Win512 help or separate Autronica documents.

Connections according to dwg 512-48.

Break or short circuit on a BS4 loop

Normally the control unit communicates with the units in one direction, which is automatically changed every 60 seconds.

I.e. a break on a BS4 loop, between "the last unit" and the control unit, will generate a fault within 60-100 seconds (EN54 requirement).

By a single break on a loop, between the control unit and the last unit, the following will happen:

- Communication will start in both directions.
- Since it is a single break all units will now be "found" by the control unit. A fault is generated and a fault message is shown:
FAULT: Cut-off loop x, BS4 x, CU xx
- Each 10th minute is an attempt made to communicate in one direction again. When the break is repaired the communication in one direction starts again.
- Fault acknowledge, see EBL512 Operating Instructions.

By two or more breaks on a loop, between the control unit and the last unit, the following will happen:

- Communication will start in both directions.
- Since it is not a single break all units will not be "found" by the control unit. A fault is generated for each unit not found and fault messages are shown:
FAULT: No reply techn. no. xxxxxx

- Each 10th minute is an attempt made to communicate in one direction again. When the breaks are repaired the communication in one direction starts again.
- Fault acknowledge, see EBL512 Operating Instructions.

By a short circuit on a loop, the following will happen:

- Communication will stop. The loop is disabled.
- A fault is generated and a fault message is shown:
FAULT: Short circ. loop x, BS4 x, CU xx
- Each 10th minute is an attempt made to re-enable the loop. When the short circuit is repaired the communication starts again.
- Fault acknowledge, see EBL512 Operating Instructions.

NOTE! If one or more short circuit isolators are used, the loop will be divided into "segments" (the part between two short circuit isolators or between the control unit and one short circuit isolator). Only the affected segment will be isolated, which will minimise the number of units disabled by a short circuit.

6.7 External FBP / DU interface board 1587

Up to **two** 1587 boards can be used.^{25 29}

(The 1587 board has now replaced the 1582 board, see page 29).

Each board has to be programmed (Win512) regarding:

- Address (= the address set with jumpers on the board, i.e. 0 or 1)
- Name (Default is **FBP/DU 1587**, which is normally not changed)

This board is an interface, only for Ext. FBPs 1826 / 1828, Presentation unit 1728 and Alert annunciation units 1735 / 1736 running in **S/W mode xxxx – 1587**.³⁰ The data rate in this mode is 9600 baud.

The theoretical number of units that can be connected to the board is sixteen but it is depending on the type and the number of the units respectively, the cable type and length, etc.

Connections according to dwg 512-47.

²⁹ **NOTE!** Because of high components on the board, a 1587 board always has to be mounted "on top". This is also valid for the 1582 board, i.e. $1582 + 1587 \leq$ two boards. When no other boards are used, only one 1582 / 1587 board can be used. **As from February 2005, eight spacer bolts are supplied with each 1582 / 1587 board, which makes it possible to mount these two boards in any expansion board position in the control unit.**

³⁰ For more information about each type of unit, see chapter "Other units", page 64.

7 Printer board 1558

The control unit type 1549 has a factory mounted printer board 1558.

The control unit type 1548 can be provided with a printer board 1558. It is mounted on the inner door backside and is at the same time connected to the main board 1556.

When the printer board 1558 is mounted, the checkbox "Printer board connected to Main board" has to be marked in the Win512 "Control Unit" dialog box.

8 TLON connection board 1590

One TLON connection board 1590 is used in each control unit connected to a TLON network.³¹

This board is mounted on the main board 1556 and the network is connected to the connection board 1555 according to dwg 512-44.

The PC program TLON Manager is used for the required TLON network programming.

NOTE! By the TLON network programming, some unique data will be stored in a memory on the 1590 TLON connection board and some unique data will be stored in a memory on the 1556 main board.

After replacing a TLON connection board to another or replacing both a TLON connection board and a main board, do "Replace", "Update" and "Save" in TLON Manager.

After replacing a main board to another (not the TLON connection board), do "Update" and "Save" in TLON Manager.

³¹ A single (standalone) control unit must not have a TLON connection board 1590 mounted.

9 Peripheral devices

Alarm points. **Analog** are connected directly to the COM loops. **Conventional** to 8 zones expansion boards (1580) and input units on the COM loop. Programmable inputs are also available.

Short circuit isolators are connected to COM loops.

Sounders, door release magnets, etc. are connected to output units connected to the COM loops and/or control unit (outputs S0-S3, R0-R1 and/or 8 relays expansion boards 1581). Addressable are connected directly to the COM loops.

Input devices as key cabinet, timers, external faults, etc. are connected to programmable inputs (i.e. to input units connected to the COM loops and/or inputs in the control unit).

Display units. Earlier types were connected to COM loops. The current types are connected via Ext. FBP/DU interface board(s) (1587).

Routing equipment is normally connected to the control unit outputs Fire brigade tx & Fault tx. (Alt. programmable outputs can be used).

External Fire Brigade Panels and External Displays Units are connected via Ext. FBP/DU interface board(s) (1587).

German external Fire Brigade Panel (*Feuerwehr-Bedienfeld*) is connected to German FBP interface board 1583, which also has a German Extinguishing equipment interface (*VdS Standard-Schnittstelle "Löschen"*).

Regarding abbreviations, see chapter "Definitions / Explanations", page 11.

More information, see the Product Leaflet for the device respectively.

9.1 COM loop units

Each COM loop can handle up to 127 addressable COM loop units. Depending on the type of units and the number of units the total current consumption will vary and this will affect the cable length. See chapter "Current consumption", page 152 and drawing 512-01.

NOTE! The control unit can be configured for up to 128, 256 or 512 addresses (COM loop units). Normally this is factory set but can be changed on site (via Win512)³². In menu H4/U8 is the current configuration shown. The units should be distributed as even as possible on each COM loop and between the COM loops (0, 1, 2 & 3).

³² This action requires a separate download password, see EBL512 Operating Instructions.

Address setting

Each COM loop unit has to have a unique address, set with an Address Setting Tool 3314 (see **AST** in the Figure 5).

For some older types of units the address is set on a DIL switch in the unit respectively (see **A** in the Figure 5).

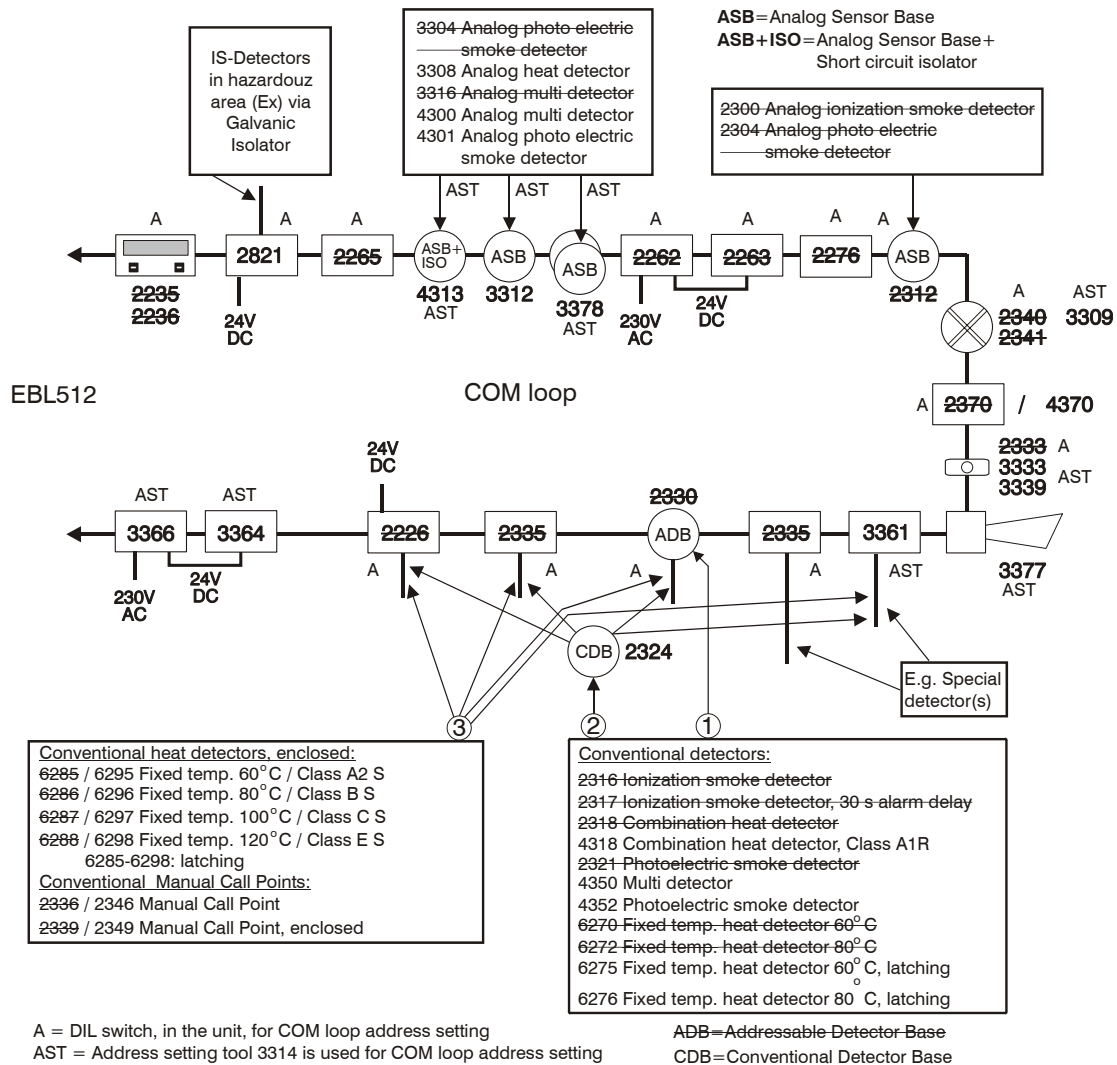

Figure 5. COM loop units; overview. For more information regarding COM loop units, see the following chapters. NOTE! Some units might be under construction and some units are no longer in stock (marked ~~strikethrough~~) but can be found in existing installations.

- ① = Conventional Panasonic detectors to be plugged in an ~~Addressable Detector Base 2330~~ connected to a COM loop.
- ② = Conventional Panasonic detectors to be plugged in a Conventional Detector Base 2324 connected to a conventional zone line input.
- ③ = Conventional Panasonic detectors / units to be connected to a conventional zone line input.

Conventional Panasonic detectors can also be connected to an 8 zones expansion board (1580) zone line input.

Other conventional detectors, e.g. with a closing contact only (i.e. no alarm resistor), can be connected to a zone line input, i.e. to a 3361 unit or an 8 zones expansion board (1580).

Older conventional detectors, with breaking contacts, could be connected to a ~~2226~~ zone line input (loop config.).

9.1.1 Input units

Each **COM loop input unit** is to be programmed (Win512), depending on type, regarding:

- Technical number
- Zone number and Address within the zone
- Quiet alarm
- Logical Name (normally not changed)
- Alarm algorithm / Alt. Alarm algorithm (some units only)
- Time Channel; Alt. Alarm algorithm ON/OFF via a time channel
- Alert Annunciation (some units only); Always or ON/OFF via a time channel
- Two-unit-dependent fire alarm (some units only); Always or ON/OFF via a time channel
- Fire alarm delay (some units only)
- Disablement (some units only); ON/OFF via a time channel
- User definable text message, i.e. an "alarm text" (when required)

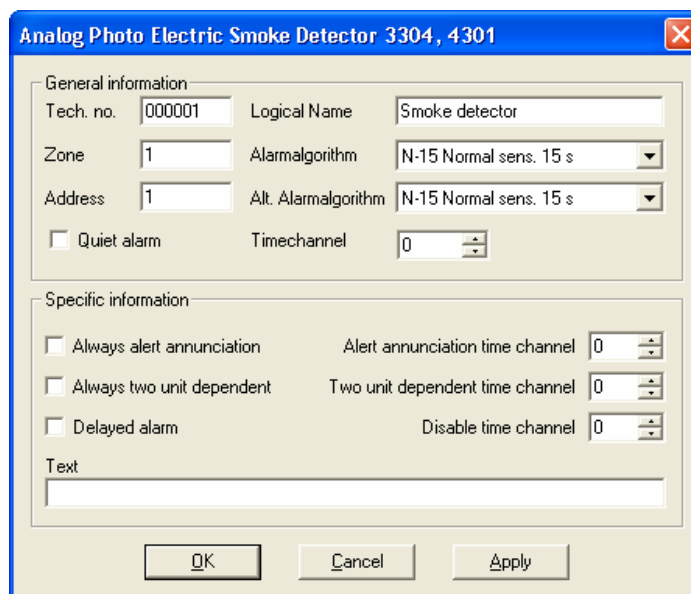

Figure 6. Win512 "Analog photo electric smoke detector 3304, 4301" (Optical Sensor) dialog box.

For more information, see Win512 help.

Connections, see dwg. 512-41, -46, -51 - -55.

NOTE! A unit marked grey (like this) = outgoing unit, not for new installations but could be found in existing installations. Many of these units are no longer in stock. For information regarding these units see documentation for earlier S/W versions.

9.1.1.1 Analog Sensor Bases (ASB)

2312 Analog Base. No longer in stock.

3312 Analog Base. Analog detectors (Sensors) to be plugged in 3312, see Figure 5, page 36. Terminals for ext. LED 2216 / 2217. Prepared for mechanical lock of the detector. Recess for label holder 3391. The base has an address label where the plugged in detector's COM loop address is to be written.

4313 Analog Base with isolator. An analog detector (Sensor) is to be plugged in 4313. Terminals for ext. LED 2217. Prepared for mechanical lock of the detector. Recess for label holder 3391. It has also a built-in short circuit isolator with the same **function** as the Addressable short circuit isolator 4370 (see page 51). The isolator's technical address is set with an Address setting tool (AST) 3314. The base has an address label on which both the plugged-in detector's technical address and the isolator's are to be written.

The Address setting tool 3314 is also used for mode setting:

NORMAL mode: Not used in system EBL512.

2330 mode: Used for 4313 in system EBL512.
(4313=2370=4370 in Win512)

2312 mode: Not used in system EBL512.

9.1.1.2 Addressable Detector Base (ADB)

2330 Addressable Base. No longer in stock.

9.1.1.3 Addressable Input Units

The best substitute for the following units is the 3361 unit, see page 48.

2335 Addressable zone interface. No longer in stock.

2226 Addressable zone interface, isolated.³³ Conventional detectors to be connected to the zone line input ("Zone"), see Figure 5, page 36. End-of-line resistor (10K or 3K3) is to be connected in the last unit on the zone line. Old detector types with breaking contacts can also be connected ("Zone Loop"). For more information see dwg 512-54. 2226 require external power

³³ In convention "British Standard Marine Application" a fire alarm generated via this unit, has a response time ≤ 5 seconds.

This unit might no longer be in stock.

supply 24V DC (30mA). DIL-switch for address setting.
To be mounted in an E1-box / frame (min. 50mm), a Swedish 65mm circular mounting box. or a Waterproof box (IP66 / 67) 3362 that also has four compression glands for the cables.

2276 Addressable 8 inputs unit. No longer in stock.

9.1.1.4

Addressable Manual Call Points

2333 Addressable Manual Call Point. No longer in stock.

3333 Addressable Manual Call Point.³⁴ Conforms with EN54-11. A built-in LED³⁵ will indicate that fire alarm is generated, i.e. the glass is broken. Routine testing can be performed with a test key³⁶ without breaking the glass. A hinged polycarbonate flap is protecting the glass. Address is set with an Address setting tool (AST) 3314. The call point has an address label where the programmed address is to be written.

The Address setting tool 3314 is also used for mode setting.³⁵

3333 is to be surface mounted in the supplied red backbox or flush mounted in a Swedish 65mm circular mounting box. For indoor use and in dry premises.

The 3333 unit is intended to replace the 2333 unit.

3339 Enclosed Addressable Manual Call Point.³⁴ Like the 3333 unit but another type of front cover and backbox. Only for surface mounting. For indoor use. Ingress Protection rating IP67.

9.1.1.5

Addressable Conventional Detectors

2340 Addressable fixed temperature heat detector, 60°C, enclosed.
No longer in stock.

2341 Addressable fixed temperature heat detector, 80°C, enclosed.
No longer in stock.

³⁴ In all conventions the manual call points have a response time ≤ 5 s.

³⁵ With the address setting tool the call point can be set in:

NORMAL mode (EBL512 S/W version >2.0 is required) = "3333 mode" and LED mode (see below) to be set in Win512.

2330 mode = "2333 mode" and "flashing LED mode" (= the LED will flash each time the control unit communicates with the m.c.p.).

2312 mode = "2333 mode" and "non-flashing LED mode".

³⁶ Supplied with the m.c.p.

9.1.1.6

Analog Detectors

2300 Analog ionization smoke detector. No longer in stock.

2304 Analog photo electric smoke detector.³⁷ No longer in stock.

3304 Analog photo electric smoke detector.³⁷ To be plugged in an ASB base 3312. Built-in LED that is lit to indicate that the detector has generated fire alarm. Prepared for mechanical lock (screw attached). The smoke detector is in Win512 set to one of the six algorithms H-15, H-35, L-15, L-35, N-15 or N-35. The address is set with an Address setting tool (AST) 3314. The detector has an address label where the programmed address is to be written.

The Address setting tool 3314 is also used for mode setting:
NORMAL mode: 3304 + base 3312 and EBL512 S/W version ≥ 2.0 . (Set as 3304 in Win512)

2330 mode: 3304 + base 3312 is a spare part for 2321³⁸ + base 2330³⁹. (Set as 2330 in Win512)

2312 mode: 3304 + base 3312 is a spare part for 2304 + base 2312.

(Set as 2304 in Win512)

3304 is an outgoing product and the analog photo electric smoke detector 4301 (in NORMAL mode) is the substitute.

3308 Analog heat detector. To be plugged in an ASB base 3312. Built-in LED that is lit to indicate that the detector has generated fire alarm. Prepared for mechanical lock (screw attached). In Win512 is set one of the three algorithms for class A1 (static response temp. 54-65°C), A2 S (54-70°C) or B S (69-85°C). The address is set with an Address setting tool (AST) 3314. The detector has an address label where the programmed address is to be written.

The Address setting tool 3314 is also used for mode setting:
NORMAL mode: 3308+3312 and EBL512 S/W version ≥ 2.0 . (Set as 3308 in Win512)

2330 mode: 3308+3312 is a spare part for 6270⁴⁰+2330³⁹, i.e. 3308 works as a class A2 S fixed temperature heat detector, 57°C.

(Set as 2330 in Win512)

2312 mode: This mode can **not** be used for 3308.

³⁷ In convention "British Standard Marine Application", the detector has a response time ≤ 10 seconds.

³⁸ 2321, 2320 or 6217.

³⁹ **NOTE!** 2330 has a conventional zone line input ("Ext. Line"). This type of input is not to be found in 3312.

⁴⁰ 6270 or 6275.

3309 Analog heat detector. Enclosed (IP67)⁴¹. Built-in LED that is lit to indicate that the detector has generated fire alarm.⁴² Recess for label holder 3391. In Win512 set to one of the three algorithms for class A1 (static response temp. 54-65°C), A2 S (54-70°C) or B S (69-85°C). The address is set with an Address setting tool (AST) 3314. The Address setting tool 3314 is also used for mode setting:

NORMAL mode: 3309 and EBL512 S/W version ≥ 2.0 . 3309 with algorithm A1 or A2 S, is a spare part for 2340 and with algorithm B S, a spare part for 2341. (Set as 3309 in Win512)

2330 mode: 3309 is a spare part for 2340, i.e. 3309 works as a class A2 enclosed fixed temperature heat detector, 57°C.

(Set as 2330 in Win512)

2312 mode: This mode can **not** be used for 3309.

3316 Analog multi detector. This is an analog smoke detector and an analog heat detector within one detector housing. To be plugged in an ASB base 3312. Built-in LED that is lit to indicate that the detector⁴³ has generated fire alarm. Prepared for mechanical lock (screw attached). Via Win512 it is programmable, which way the detectors shall operate:

a) **Two presentation numbers (addresses)**: The detector unit works as two separate detectors. The smoke detector is programmed for one zone-address and the heat detector for another zone-address⁴⁴. (Can be used to disable one of the detectors during working hours and in control expressions for programmable outputs). The detector unit has one technical number (address) used for programming and fault presentation. For the smoke detector (≈ 3304) is in Win512 set one of the six algorithms H-15, H-35, L-15, L-35, N-15 or N-35. For the heat detector (≈ 3308) is in Win512 set one of the three algorithms for class A1 (static response temp. 54-65°C), A2 S (54-70°C) or B S (69-85°C).

b) **One presentation number (address)**: The detector unit works as one detector and is programmed for one zone-address. The detector unit (actually the heat detector) can detect a methylated spirits fire (EN54-9, test fire TF6; liquid fire), which normally is impossible for a photo electric smoke detector to detect. The detector unit has one technical number (address) used for programming and fault presentation.

⁴¹ As from January 2005, this detector holds the ATEX classification: **Ex II 3GD EEx nA II T5 (T 70°C), $-20^{\circ}\text{C} \leq T_a \leq 65^{\circ}\text{C}$** .

⁴² 3309 has also terminals for ext. LED 2216 / 2217.

⁴³ I.e. the heat detector and/or the smoke detector.

⁴⁴ The zone number has to be the same for both detectors. **NOTE!** When counting alarm points these "two detectors" are regarded as two alarm points.

It is, via Win512, programmable if the detectors in alt. **b)** shall work with an "OR-functionality" or with a "Decision algorithm":

b1) OR-functionality: Either the heat detector **or** the smoke detector will activate fire alarm. This alternative is recommended in most cases. The detector unit has one technical number (address) used for programming and fault presentation. For the smoke detector (≈ 3304) is in Win512 set one of the six algorithms H-15, H-35, L-15, L-35, N-15 or N-35. For the heat detector (≈ 3308) is in Win512 set one of the three algorithms for class A1 (static response temp. 54-65°C), A2 S (54-70°C) or B S (69-85°C).

b2) Decision algorithm:

Fire alarm will be activated if:

temperature (°C) + adjusted smoke value⁴⁵ ≥ 58 .

Pre-warning will be activated if:

$58 > \text{temperature (°C) + adjusted smoke value} \geq 50$.⁴⁵

The "Decision algorithm"⁴⁶, See Figure 7, page 43, can be used to reduce so called false alarms (nuisance alarms), because at a normal room temperature, more smoke is required to activate fire alarm than when the room temperature is high (or is rising). By a real fire, the room temperature will rise rather fast and less and less smoke is required to activate fire alarm. Very little smoke require a "high" temperature to activate fire alarm and very much smoke will activate fire alarm also at a "low" temperature.

The COM loop address for 3316 is set with an Address setting tool (AST) 3314. The detector has an address label where the programmed address is to be written.

The Address setting tool 3314 is also used for mode setting:

NORMAL mode: 3316 + base 3312 and EBL512 S/W version ≥ 2.0 . (Set as 3316 in Win512)

2330 mode: This mode can **not** be used for 3316.

2312 mode: This mode can **not** be used for 3316.

⁴⁵ Adjusted smoke value = obscuration (%/m) x 10. Default heat alarm levels (50 / 58°C) and smoke alarm offsets (50 / 58) can be changed in Win512. The temperature can not be lower than 0°C in the algorithm / graph.

⁴⁶ The decision algorithm is a violation to the EN54-7 standard.

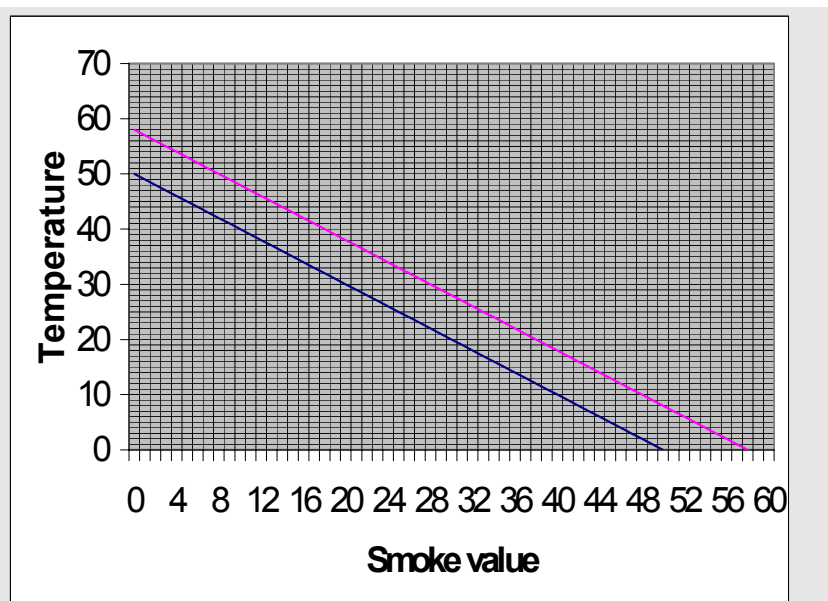

Figure 7. When the calculated value in the decision algorithm exceeds the lower graph, pre-warning will be activated. When it exceeds the upper graph, fire alarm will be activated. **Temperature = °C. Smoke value = obscuration (%/m) x 10.**

3316 is an outgoing product and the analog multi detector 4300 (in NORMAL mode) is the best substitute.

4300 Analog multi detector. A smoke detector and a heat detector in one housing. Scattered light (i.e. reflection of infrared light) is used to detect **smoke** and the **heat** sensing element is a thermistor. The function in **NORMAL mode** is as for 3316. In order to secure the fire detection and to prevent false (nuisance) alarms, the **AI function** is used in the **2330 mode**, i.e.

- a: combined heat and smoke sensing
- b: variable delay function
- c: adaptive learning function

See also chapter "Cyber sensor functions", page 125.

The detector has unleaded soldering.

To be plugged in an ASB base 3312. Built-in LEDs are lit to indicate that the detector has generated fire alarm. Prepared for mechanical lock (screw attached).

The address is set with an Address setting tool (AST) 3314. The detector has an address label where the programmed address is to be written.

The Address setting tool 3314 is also used for mode setting:

NORMAL mode: 4300 in this mode is a spare part for 3316 in NORMAL mode (EBL512 S/W version ≥ 2.0 is required.)

Set as 3316 in Win512.

2330 mode: 4300 + base 3312 is in this mode a conventional multi detector with **AI function** and is the best substitute for

2316 / 2317 + base 2330⁴⁷).

Set as 2330 in Win512.

2312 mode: Not used for 4300.

4301 Analog photo electric smoke detector. Scattered light (i.e. reflection of infrared light) is used to detect smoke. The function in **NORMAL mode** is as for 3304. In order to secure the fire detection and to prevent false (nuisance) alarms, the **AI function** is used in the **2330 mode**, i.e.

a: variable delay function

b: adaptive learning function

See also chapter "Cyber sensor functions", page 125.

The detector has unleaded soldering.

To be plugged in an ASB base 3312. Built-in LEDs are lit to indicate that the detector has generated fire alarm. Prepared for mechanical lock (screw attached).

The address is set with an Address setting tool (AST) 3314.

The detector has an address label where the programmed address is to be written.

The Address setting tool 3314 is also used for mode setting:

NORMAL mode: 4301 in this mode is a spare part for 3304 in NORMAL mode (EBL512 S/W version ≥ 2.0 is required.)

Set as 3304 in Win512.

2330 mode: 4301 + base 3312 is in this mode a conventional photoelectric smoke detector with **AI function** and can be a spare part for 2321 + base 2330.⁴⁷

Set as 2330 in Win512.

2312 mode: 4301 + base 3312 is in this mode an analog photoelectric smoke detector and can be a spare part for 2304 + base 2312.

Set as 2304 in Win512.

9.1.1.7

Conventional Detector Base (CDB)

2324 Base. Conventional detectors to be plugged in 2324, see Figure 5, page 36. Built-in LED that is lit to indicate that the detector in the base has generated fire alarm. Terminals for ext. LED 2216 / 2217.

9.1.1.8

Conventional Detectors

2316 Ionization smoke detector. No longer in stock.

2317 Ionization smoke detector, 30 sec. alarm delay. No longer in stock.

⁴⁷ **NOTE!** 2330 has a conventional zone line input ("Ext. Line"). This type of input is not to be found in 3312.

2318 Combination heat detector. Rate-of-rise **and** fixed temperature, 58°C, heat detector. Will be replaced by 4318, see below. To be plugged in an ADB 2330 or a CDB 2324.

4318 Combination heat detector. Rate-of-rise **and** fixed temperature, 59°C, heat detector class **A1 R**. Static response temp. range 54-70°C, min./**typical**/max. ambient temp. -20/+25/+50°C:
Will replace 2318. To be plugged in a CDB 2324.

2321 Photo electric smoke detector. No longer in stock.

4350 Multi detector. A smoke detector and a heat detector in one housing. Scattered light (i.e. reflection of infrared light) is used to detect **smoke** and the **heat** sensing element is a thermistor. In order to secure the fire detection and to prevent false (nuisance) alarms, the AI function is used, i.e.

a: combined heat and smoke sensing

b: variable delay function

c: adaptive learning function

See also chapter "Cyber sensor functions", page 125.

The detector has unleaded soldering.

To be plugged in a CDB 2324.

4350 is the best substitute for the ionization smoke detectors 2316 and 2317.

4352 Photoelectric smoke detector. Scattered light (i.e. reflection of infrared light) is used to detect smoke. An advanced alarm algorithm is used to secure the smoke detection and to prevent false (nuisance) alarms, e.g. a minimum of nine consecutive readings over the fire alarm level are required, before the detector goes into alarm. (One reading per sec.)

The detector has unleaded soldering.

To be plugged in a CDB 2324.

4352 is a spare part for the photoelectric smoke detector 2321.

6270 Heat detector. No longer in stock.

6272 Heat detector. No longer in stock.

6275 Heat detector. Fixed temperature heat detector, 60°C, latching.
To be plugged in an ADB 2330 or a CDB 2324.

6276 Heat detector. Fixed temperature heat detector, 80°C, latching.
To be plugged in an ADB 2330 or a CDB 2324.

6285 Heat detector. No longer in stock.

6286 Heat detector. No longer in stock.

6287 Heat detector. No longer in stock.

6288 Heat detector. No longer in stock.

6295 Heat detector: Enclosed (IP67)⁴⁸. Fixed temperature (57°C) heat detector, class A2 S (static response temp. 54-70°C), latching. Built-in LED that is lit to indicate that the detector has generated fire alarm. Terminals for ext. LED 2216 / 2217.

The 6295 unit is a spare part for the 6285 unit.

6296 Heat detector: Enclosed (IP67)⁴⁹. Fixed temperature (72°C) heat detector, class B S (static response temp. 69-85°C), latching. Built-in LED that is lit to indicate that the detector has generated fire alarm. Terminals for ext. LED 2216 / 2217.

The 6296 unit is a spare part for the 6286 unit.

6297 Heat detector: Enclosed (IP67). Fixed temperature (87°C) heat detector, class C S (static response temp. 84-100°C), latching. Built-in LED that is lit to indicate that the detector has generated fire alarm. Terminals for ext. LED 2216 / 2217.

The 6297 unit is a spare part for the 6287 unit.

6298 Heat detector: Enclosed (IP67). Fixed temperature (117°C) heat detector, class E S (static response temp. 114-130°C), latching. Terminals for ext. LED 2216 / 2217 (to indicate that the detector has generated fire alarm).

The 6298 unit is a spare part for the 6288 unit.

9.1.1.9

Conventional Manual Call Points

2336 Manual call point. No longer in stock.

2339 Manual call point. No longer in stock.

9.1.1.10

Accessories

3314 Address setting tool. Is used to write or read the 33xx / 43xx units' **COM loop address** (001-127). It is also used to write or read the mode, **NORMAL**, **2330** or **2312** (see the 33xx / 43xx unit respectively). A connection cable (with crocodile clips / push-on terminals) is attached and can be used when required.

Put the ON/OFF switch in pos. ON and wait for a beep. Plug the detector into 3314 (SA & SB terminals) or when required, use the connection cable⁵⁰.

How to read: Press "READ", wait for a beep and read the address and mode.

How to write: Press "WRITE" and "READ" at the same time to

⁴⁸ As from January 2005, this detector holds the ATEX classification: **Ex II 3GD EEx nA II T5 (T 100°C), -40°C ≤ T_a ≤ 50°C**.

⁴⁹ As from January 2005, this detector holds the ATEX classification: **Ex II 3GD EEx nA II T5 (T 100°C), -40°C ≤ T_a ≤ 65°C**.

⁵⁰ Some units have flying leads for easier connection. After use they may be disconnected and thrown away.

select the mode **and/or** write the address and press "WRITE".
Wait for a beep. ("READ" again as a check.)

- 3390** Label holder. Can be mounted in the analog base 3312⁵¹. Intended for a label with "zone-address", "technical number", etc. The label can be read also when the detector is plugged in its base. 100 label holders per packet. Excl. labels.
- 3391** Labels for 3390. Self-adhesive white labels for label holder 3390. 10 A4-sheets à 132 labels per packet. For e.g. laser printer usage. The print-out can be done via Win512 (File menu | Print labels...).

⁵¹ Also in the enclosed analog heat detector 3309.

9.1.2 Output units (addressable)

Each **COM loop output unit** is to be programmed (Win512) regarding:

- Technical number
- Logical Name (Normally not changed)
- Type
- Activation time and type (steady, pulse delay, etc.)
- Logic, i.e. relay outputs normally open (NO) **or** normally closed (NC) contacts
alt.
voltage outputs (24V DC) normally low⁵² **or** normally high⁵³.
- Control expression

For more information, see Win512 help or chapter "Programmable outputs", page 73.

Connections, see dwg. 512-61.

NOTE! A unit marked grey (like this) = outgoing unit, not for new installations. Many of these units are no longer in stock. For information regarding these units see documentation for earlier S/W versions.

2262 Addressable 4 outputs unit with power supply⁵⁴. No longer in stock.

2263 Addressable 4 outputs unit without power supply⁵⁴. No longer in stock.

2265 Addressable 4 relays output unit. No longer in stock.

9.1.3 I / O units (addressable)

3361 Addressable multipurpose I / O unit. Power supplied via the COM loop. The unit has **two programmable** inputs:

Monitored input

...used as **zone line input (Z)**: End-of-line capacitor 470 nF mounted in the last unit on the line. Short circuit can activate fault or fire alarm (set via Win512). This input is intended for conventional detectors.⁵⁶

⁵² A normally low output can be set to not supervised.

⁵³ A normally high output is not supervised.

⁵⁴ Up to 20 output units 2262 + 2263 can be programmed per c.i.e.

⁵⁵ **NOTE!** These outputs will be de-activated 10 min. after loss of 230V AC.

⁵⁶ The zone line input can, as an alternative, be set (via Win512) to function exactly as a manual call point regarding disablement, two-unit-dependence and delayed alarm.

The zone line input can, as an alternative, be used for a single "slave" unit

...used as general input (In0): An input for NC or NO contacts (set via Win512).

Isolated input (In1): An optocoupler input (external 24 V DC / 8 mA required). Normally low or high (set via Win512).

The unit has two **programmable** outputs:

Relay output (Re0): NC or NO contacts (set via Win512).

Relay output (Re1): NC or NO contacts (set via Win512).

Connections and examples, see dwg. 512-57. The unit's dimensions: (L x W x H) 90 x 70 x 32 mm. A plastic protection cover is attached. The cover's dimensions: (L x W x H) 129 x 73 x 45 mm. The unit is intended to be surface mounted and for indoor use in dry premises. When required, the unit can be mounted in a Waterproof box (IP66 / 67) 3362. The unit has an LED to indicate communication to the unit or alarm condition. For more information, see the Product Leaflet. The COM loop address is set with an Address setting tool (AST) 3314. The unit has an address label where the programmed address is to be written.

The Address setting tool 3314 is also used for mode setting:

NORMAL mode: 3361 (EBL512 S/W version \geq 2.0 required.)
Set as 3361 in Win512.

2330 mode: This mode can **not** be used for 3361.

2312 mode: This mode can **not** be used for 3361.

NOTE!

The Addressable multipurpose I / O unit 3361 can be used in conjunction with the I/O Matrix board 4582 and an application board for fan control. In this case the dialog box in Win512 for programming the unit looks a bit different from the normal dialog box (but it is a normal 3361 unit).

3364 Addressable 2 voltage outputs unit. The unit is connected directly to the COM loop. An external 24 V DC power supply unit is required, e.g. 3366.

The unit has two programmable and supervised voltage outputs (VO0-VO1), intended for alarm devices (e.g. sirens). An end-of-line capacitor (470nF) is to be mounted in the last device alt. a capacitor (470nF) in up to five alarm devices:

The unit also has a special voltage output (VO2) intended for fire door closing only. The trigger condition "Fire door closing" and the controlling detectors have to be programmed. The "fire door closing function" is described on page 92 and besides that function, the output VO2 will also be powerless approx. 30 sec. after:

(control unit) or several control units connected in parallel, see chapter "Redundancy in distributed system", page 118.

- the "/Mains OK input" (terminal 8.) goes high, see below.
- the COM loop communication is interrupted = 3364 has no connection / communication with EBL512.

Also the outputs VO0 and VO1 can be programmed for the fire door closing function like the special output VO2.

The unit also has two inputs, i.e. one for power supply (24 V DC) and one for "/Mains OK".

VO0: Normally low or high (set via Win512), 24 V DC, 1 A.⁵⁷

VO1: Normally low or high (set via Win512), 24 V DC, 1 A.⁵⁷

VO2: Normally high, 24 V DC, 1 A.⁵⁷ (Fire door closing function.)

24 V DC: From an external power supply unit (e.g. 3366)

/Mains OK: From an external power supply unit (3366) when the fire door closing function (ABDL) is to be used. Normally low = The main power source (230 V AC) in the External power supply unit is okay.

Connections and examples, see drawing 512-63. The unit's dimensions: (L x W x H) 90 x 70 x 32 mm. A plastic protection cover is attached. The cover's dimensions: (L x W x H) 129 x 73 x 45 mm. The unit is intended to be surface mounted and for indoor use in dry premises. When required, the unit can be mounted in a Waterproof box (IP66 / 67) 3362.

For more information, see the Technical Description and the Product Leaflet.

The technical address is set with an Address setting tool (AST) 3314. The unit has an address label on which the programmed address is to be written.

The Address setting tool 3314 is also used for mode setting:

NORMAL mode: Used for 3364 in EBL512 with S/W version ≥ 2.3 .

2330 mode: Used for 3364 in EBL512 with S/W version $\leq 2.2.x$. (Set as 2262; outputs 0, 1 and 3 in Win512.)

2312 mode: Not used for 3364.

9.1.4 Alarm devices (addressable sounders)

3377 Addressable siren. The siren is connected directly to the COM loop. It is power supplied via the COM loop, i.e. the number of sirens is depending on the type and number of other units connected to the same COM loop. Red ABS plastic housing. Three tones and priority levels are available. For each level an output control expression and a tone is programmed (via Win512). For more technical data, see the Product Leaflet.

The COM loop address is set with an Address setting tool (AST) 3314. The siren has an address label where the programmed address is to be written.

The Address setting tool 3314 is also used for mode setting:

⁵⁷ Cont. 1 A, during 10 ms 1.4 A.

NORMAL mode: 3377 (EBL512 S/W version \geq 2.2 required.)
Set as 3377 in Win512.

2330 mode: This mode can **not** be used for 3377.

2312 mode: This mode can **not** be used for 3377.

3378 Addressable sounder base. 3378 consists of an analog base (3312) mounted together with a sounder. The sounder is mounted in the ceiling. Two flying leads from the base are plugged in the sounder. The base is thereafter mounted on the sounder, so that the detector can be plugged in the base. The base is connected directly to the COM loop. (Like base 3312.) It is power supplied via the COM loop, i.e. the number of sounder bases is depending on the type and number of other units connected to the same COM loop. For more technical data, see the Product Leaflet.

The COM loop address is set with an Address setting tool (AST) 3314. The unit has an address label where the programmed address is to be written. (The detector has its own address set via the Address setting tool 3314.)

The Address setting tool 3314 is also used for mode setting:

NORMAL mode: 3378 (EBL512 S/W version \geq 2.2 required.)
Set as 3378 in Win512.

2330 mode: This mode can **not** be used for 3378.

2312 mode: This mode can **not** be used for 3378.

9.1.5 **Display units (addressable)**

Display units ("alphanumeric displays") connected to the COM loops.

2235 Display unit with alert annunciation. No longer in stock.

2236 Display unit without alert annunciation. No longer in stock.

9.1.6 **Short circuit isolator (addressable)**

Each COM loop short circuit isolator is to be programmed (Win512) regarding:

- Technical number
- Logical Name (Normally not changed)
- Serial Number

Connections, see dwg. 512-53. (See especially about the **L** wire!)

2370 Addressable short circuit isolator. No longer in stock.

NOTE! 2370 is replaced with the fully compatible 4370 and 4313.

4313 Analog base with isolator. An analog base with a built-in short circuit isolator with the same **function** as the Addressable short circuit isolator 4370, see below. See also page 38.

4370 Addressable short circuit isolator. In case of a short circuit on a COM loop, the number of disabled units will be minimised. 4370 will replace 2370, i.e. the functions are the same. 4370 is power supplied via the COM loop. The unit's dimensions: (L x W x H) 90 x 70 x 32 mm. A plastic protection cover is

attached. The cover's dimensions: (L x W x H) 129 x 73 x 45 mm. The unit is intended to be surface mounted and for indoor use in dry premises. When required, the unit can be mounted in a Waterproof box (IP66 / 67) 3362. The unit has an input to manually open the isolator ("isolated state") and an input to manually close the isolator ("normal state"). An LED will indicate the normal and isolated state respectively. For more information, see the Product Leaflet. The COM loop address is set with an Address setting tool (AST) 3314. The unit has an address label where the programmed address is to be written.

The Address setting tool 3314 is also used for mode setting:

NORMAL mode: This mode can **not** be used for 4370.

2330 mode: Short circuit isolator 4370 (2370=4370=4313 in Win512.)

2312 mode: This mode can **not** be used for 4370.

According to the EN54 standard, one isolator is required per 32 alarm points on a COM loop.

Up to eight isolators can be used on each COM loop, which gives nine loop segments. Each isolator has to be given a Serial Number, 0-7. The isolators have to be connected consecutively (Serial Number 0 – 1 – 2 -3 -4 – 5 – 6 - 7) in the COM loop A direction.

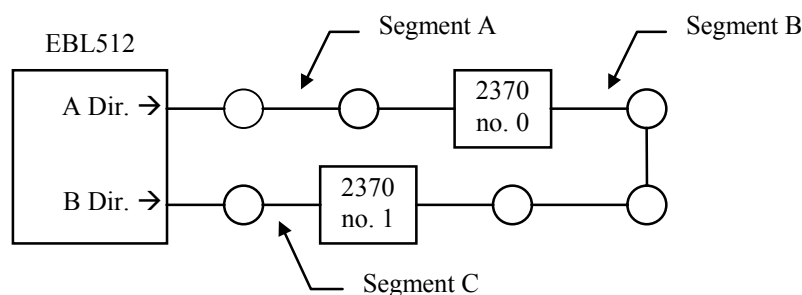

Figure 8. Two 4370 isolators (2370=4370=4313) connected to a COM loop gives three loop segments (Segment A, B and C). If one more isolator is to be connected between serial no. 0 and 1 in the figure, the new one will be serial no. 1 and the old serial no. 1 will be serial no. 2. (This also require programming via Win512.)

Short circuit

Short circuit⁵⁸ between the **L** and **C** wires on a COM loop with one or more isolators connected, will activate one or two isolators, generate a fault in the c.i.e. and one of the following messages will be shown:

⁵⁸ Short circuit ≥ 1-10 seconds (depending on the cable length and where on the loop the short circuit is located).

```
FAULT:Sh-circ loop x, CU xx, CU <->ASF0
FAULT:Sh-circ loop x, CU xx,ASF0<->ASF1
FAULT:Sh-circ loop x, CU xx,ASF1<->ASF2
FAULT:Sh-circ loop x, CU xx,ASF2<->ASF3
FAULT:Sh-circ loop x, CU xx,ASF3<->ASF4
FAULT:Sh-circ loop x, CU xx,ASF4<->ASF5
FAULT:Sh-circ loop x, CU xx,ASF5<->ASF6
FAULT:Sh-circ loop x, CU xx,ASF6<->ASF7
FAULT:Sh-circ. loop x, CU xx, ASF7<->CU
FAULT:Sh-circ. loop x, CU xx, ASF6<->CU
FAULT:Sh-circ. loop x, CU xx, ASF5<->CU
FAULT:Sh-circ. loop x, CU xx, ASF4<->CU
FAULT:Sh-circ. loop x, CU xx, ASF3<->CU
FAULT:Sh-circ. loop x, CU xx, ASF2<->CU
FAULT:Sh-circ. loop x, CU xx, ASF1<->CU
FAULT:Sh-circ. loop x, CU xx, ASF0<->CU
```

CU = Control Unit (C.i.e.). **ASF** = Addr. short circuit isolator.

<-> = between (i.e. the disabled segment).

Each 10th minute, an attempt is made to de-activate the isolator(s), i.e. when the short circuit is gone, the segment will be re-enabled again and the isolated units will work normally again within 10 minutes.

Break

A single break on a loop will result in a two way communication on the loop, a fault is generated in the c.i.e. and one of the following messages will be shown:

```
FAULT:Cut-off loop x, CU xx, CU <->ASF0
FAULT:Cut-off loop x, CU xx,ASF 0<->ASF 1
FAULT:Cut-off loop x, CU xx,ASF 1<->ASF 2
FAULT:Cut-off loop x, CU xx,ASF 2<->ASF 3
FAULT:Cut-off loop x, CU xx,ASF 3<->ASF 4
FAULT:Cut-off loop x, CU xx,ASF 4<->ASF 5
FAULT:Cut-off loop x, CU xx,ASF 5<->ASF 6
FAULT:Cut-off loop x, CU xx,ASF 6<->ASF 7
FAULT:Cut-off loop x, CU xx,ASF 7<->CU
FAULT:Cut-off loop x, CU xx,ASF 6<->CU
FAULT:Cut-off loop x, CU xx,ASF 5<->CU
FAULT:Cut-off loop x, CU xx,ASF 4<->CU
FAULT:Cut-off loop x, CU xx,ASF 3<->CU
FAULT:Cut-off loop x, CU xx,ASF 2<->CU
FAULT:Cut-off loop x, CU xx,ASF 1<->CU
FAULT:Cut-off loop x, CU xx,ASF 0<->CU
```

CU = Control Unit (C.i.e.). **ASF** = Addr. short circuit isolator.

<-> = between (i.e. the segment with a break). Cut-off = break.

Each 10th minute, an attempt is made to communicate in one direction again. When the break is repaired the communication in one direction starts again within 10 minutes.

By two or more breaks on a loop, the same is valid as for a single break plus a fault message for each unit not found by the control unit:

FAULT: No reply techn.no. xxxxxx

Each 10th minute, an attempt is made to communicate in one direction again. When the breaks are repaired the communication in one direction starts again within 10 minutes.

9.1.7

Other COM loop units

3366 External power supply. Conforms to EN54-4. The unit is connected to a COM loop, i.e. it is monitored from EBL512 and e.g. loss of the main power source will generate a fault in EBL512. Can be used as power supply for external equipment requiring 24 V DC with battery backup, e.g. the 3364 unit. It also has a "/Mains OK" output (normally low), intended to be connected to the corresponding input on the 3364 unit.

A light grey metal housing (HxWxD, 288 x 400 x 95 mm). There is **space** for two maintenance-free sealed Lead-Acid backup batteries, 2 x 12 V, 7.5 Ah as the second power source. Batteries with higher capacity (up to 60 Ah) have to be placed outside the housing. There are cable inlets on the top, bottom and back sides of the housing. Two compression glands are attached.

The unit has a **24 V DC⁵⁹ power supply output** for external equipment with up to **2.2 A** or **0.85 A** continuous current consumption, at the same time as the battery charging is in progress.⁶⁰ In case of no battery charging, the continuous current consumption can be up to **4 A**.

It has a number of security functions against to high current output, to low battery voltage etc. For more information, see the Technical Description and the Product Leaflet.

The address is set with an Address setting tool (AST) 3314. The unit has an address label on which the programmed address is to be written.

The Address setting tool 3314 is also used for mode setting:

NORMAL mode: Used for 3366 in EBL512 with S/W version ≥ 2.3 .

2330 mode: Used for 3366 in EBL512 with S/W version \leq

⁵⁹ The rated output voltage for the main power source (rectifier) is 24 V \pm 1%. Max. ripple 500 mVp-p. The rated output voltage for the second power source (the backup battery) is 21 – 28 V DC. **NOTE!** The voltage will, however, decrease to approx. 15 V when the output will be switched off in order not to damage the battery.

⁶⁰ A current consumption of **0.85-2.2 A** allows only the "**low current charging mode**", i.e. the battery capacity can be **up to 27 Ah** (in fact up to 34 Ah but such a battery is not available).

A current consumption $\leq 0.85 A$ allows the "**high current charging mode**", i.e. the battery capacity can be **up to 60 Ah**.

2.2.x. (Set as 2262 in Win512.)

2312 mode: Not used for 3366.

4582 I/O Matrix board.⁶¹ This board makes it possible for any retailer to manufacture and connect three different types of "Application boards" to EBL512 via the COM loops.

The I/O Matrix board (80 x 63 mm) is plugged ("piggy back" connection) to the Application board respectively and it has 16 inputs and 48 outputs. The COM loop and 24 V DC is connected to Application board. Three different application board types can be selected via jumpers (JP4-JP5) on the I/O Matrix board:

Fan control and indicating panel, for four Fan control panels, each with six LED:s (On / Auto / Off / Running / Stopped / Fault) and three push buttons (On / Auto / Off). One "Reset" switch. Can be used for a "Supply air fan" or a "Standard fan".

Zone control and indicating panel, with outputs and inputs for 16 zone LED:s (Alarm / Fault / Disabled) and 16 push buttons (Disable).

Generic control and indicating panel (Mimic panel alt. New Zealand indication panel), with 16 inputs (any input trigger condition can be used) and 48 outputs (any output trigger condition can be used).

There is no COM loop address to be set. Instead, the board number (0-3) on the COM loop is set with jumpers (JP1-JP2) on the I/O Matrix board respectively, i.e. up to four I/O Matrix boards can be connected to each COM loop.

Up to sixteen I/O Matrix boards per EBL512 can be used but max. four I/O Matrix boards of the types Generic and Zone.

For more information, see the I/O Matrix board 4582, Technical description MEW00914.

AAFC Alarm Acknowledgement Facility Control.⁶¹ **NOTE!** The **AAFC unit** and the **Alarm Acknowledgement Facility** are valid for the **Australian convention only**.

The **AAFC** is a box with an alarm indication LED and a non-latching switch, "Press to acknowledge false alarm". One AAFC per AAFC zone and up to 100 AAFC:s per c.i.e. can be used. The COM loop address is set with an Address setting tool (AST) 3314. See also chapter "Alarm Acknowledgement Facility (AAF)", page 105.

9.2 BS4 loop units

Each BS4 loop can handle up to 99 addressable BS4 loop units. Regarding the BS4 loop units (Autronica sensors, zone interfaces, manual call points, etc.), see separate Autronica documents.

⁶¹ This unit is available on the Australian market only.

NOTE! The control unit can be configured for up to 128, 256 or 512 addresses (BS4 loop units). Normally this is factory set but can be changed on site (via Win512)⁶². In menu H4/U8 is the current configuration shown.

Address setting

Each unit on a BS4 loop has to have a unique address. This is set on a DIL switch in each unit.

9.3 Units for Hazardous (Ex) areas

In hazardous (Ex) areas, **Intrinsically Safe (IS)** and approved products are required. Connected to the COM loop is an Addressable IS zone interface. The IS alarm points are connected to a detector interface, i.e. a Galvanic isolator, which is connected to the Addressable IS zone interface. See also dwg. 512-55.

9.3.1 Addressable IS zone interface (AIS)

2821 Addressable IS zone interface. The interface is connected to a COM loop. It has a zone line input. An end-of-line resistor (10K) is to be connected in the last unit on the zone line. It has a DIL-switch for the COM loop address setting. External power supply 24 V DC (30mA) is required. The interface is mounted in a Waterproof box (IP66/67) that also has four compression glands for the cable entries. Box dimensions (L x W x H): 175 x 125 x 75 mm.

9.3.2 Galvanic isolator

MTL5061 Galvanic isolator. The isolator is used to connect IS detectors and manual call points to the Addressable IS zone interface zone line input. The isolator has two inputs and two outputs (Channel 1 & 2) and it is mounted in a Waterproof box (IP66/67). Four compression glands for the cable entries and an end-of-line resistor (10K) with an area >230 mm² are supplied. Box dimensions (L x W x H): 175 x 125 x 150 mm. BASEEFA classification: EEx ia IIC.

9.3.3 Intrinsically Safe mounting base

YBN-R / 4 IS Intrinsically Safe mounting base. In the base can be plugged an intrinsically safe conventional smoke or heat detector. The base has terminals for the zone line (in/out) and for an ext. LED.

9.3.4 Intrinsically Safe photoelectric smoke detector

SLR-E-IS Intrinsically Safe photoelectric smoke detector.

A conventional photoelectric (optical) smoke detector, to be plugged in the intrinsically safe mounting base. The detector

⁶² This action requires a separate download password, see EBL512 Operating Instructions.

has two built-in LEDs that are lit to indicate that the detector has generated fire alarm. Zone classification: 0, 1 or 2. BASEEFA classification: EEx ia IIC T5, t (amb.)=50°C. Max 20 per zone.

9.3.5 Intrinsically Safe heat detector

DCD-1E-IS Intrinsically Safe heat detector. A conventional Rate of Rise heat detector, fixed temperature 60°C (class A1), to be plugged in the intrinsically safe mounting base. Two built-in LEDs that are lit to indicate that the detector has generated fire alarm. Zone classification: Category 1 (incl. lower categories). BASEEFA classification: II 1 G EEx ia IIC T5, t (amb.)=55°C. Max 20 per zone.

9.4 Units connected to the Ext. FBP interface board 1582 and the Ext. FBP / DU interface board 1587

NOTE! A unit marked grey (like this) = outgoing unit, not for new installations. Many of these units are no longer in stock. For information regarding these units see documentation for earlier S/W versions.

Ext. FBP interface board 1582

Ext. FBPs (2425 / 2426), ext. presentation display (2428) and Data converters⁶³ are connected to an Ext. FBP interface board 1582 (expansion board in the control unit (c.i.e.)). Also the Ext. FBPs (1826 / 1828) and Ext. Presentation unit (1728) **in S/W mode xxxx – 1582** are connected to an Ext. FBP interface board 1582. Regarding the 1582 board, see dwg 512-47 and chapter "External Fire Brigade Panel (FBP) interface board 1582", page 29. 2425, 2426 and 2428 are outgoing units.

Ext. FBPs (1826 / 1828), ext. Presentation unit (1728) and Alert annunciation units (1735 / 1736) are connected to an Ext. FBP / DU interface board 1587 (expansion board in the control unit (c.i.e.)). Regarding the 1587 board, see dwg 512-47 and chapter "External FBP / DU interface board 1587", page 32.

These units are intended to succeed / replace the outgoing 2425, 2426 and 2428 units as well as the 2235 & 2236 units. See the unit respectively below.

Address setting

The outgoing units incl. the data converters have a DIL-switch for address setting.

⁶³ This type of Data converters are no longer in stock, i.e. they are replaced by the web-server 1588.

In the new units are the display and the push buttons (in the unit) used to set the address, which also can be changed via the c.i.e. See the Technical Description for the unit respectively.

Ext. FBP interface board 1582

The first unit shall have the address 01, the second unit address 02 and so on⁶⁴. The DIL-switch has four switches (1 – 2 – 3 - 4). Follow the address setting instructions for the ADB 2330 DIL-switch (addresses 00-15), see dwg. 512-71. The number of units connected to one board has to be programmed via Win512. The number of units is depending on all other units connected to the same board.

Ext. FBP / DU interface board 1587

The first unit shall have the address 00, the second unit address 01 and so on⁶⁵. Follow the Address setting instructions in the Technical Description for Ext. FBP:s 1826 / 1828. The number of units connected to one board is depending on all other units connected to the same board, the cable length, etc. The highest address is 15.

Via Win512 "Selective alarm presentation" can be programmed, i.e. you can select which alarms that shall be presented in each unit, see the Technical Description for the unit respectively.

The fire brigade panel is a part of the control unit front, see Figure 2, page 22. An external fire brigade panel (ext. FBP) is a separate unit intended to be used by the fire brigade personnel. Required fire brigade personnel manoeuvres can be performed from the FBP. Depending on country (language), convention (functions), configuration, etc. the look might vary.

The external presentation display and presentation unit are units for presentation of fire alarms, i.e. zone number, address and a user definable text message, an "alarm text" (if programmed). Depending on country (language), convention (functions), configuration, etc. the look might vary.

The data converters 229x are no longer in stock, i.e. they are replaced by the web-server 1588.

9.4.1

External Fire Brigade Panels

1826 External Fire Brigade Panel (FBP) A light grey metal housing (HxWxD, 288 x 400 x 95 mm) with a door. A key is required to open the door, which has a Plexiglas in front of the FBP front. It has cable inlets on the top, bottom and back sides and

⁶⁴ A data converter can have address 00 if another unit has address 01. The data converter with the address 00 is only a receiver ("listener"), i.e. no Silence or Reset signals or data converter fault can be transmitted back to the control unit (c.i.e.).

⁶⁵ The connection order on the line is not dependent of the address.

is intended to be wall mounted. Two compression glands TET are attached.

LED indicators and push buttons on the front are like the control unit FBP (upper black part of the front), see Figure 2, page 22. **The front's designation texts are in Swedish.** A neutral front is available, where the **designation texts, in any language**, are made separately and by production put into a transparent "text slot" for the LED and push button respectively. All or selected alarms will be presented in a display (alphanumeric LCD, 2x40 characters), with back-light. A user definable text message will also be presented together with each alarm, if programmed in the c.i.e. Furthermore, at least 617 texts can for selected fire alarms be stored in the unit and will in such a case be shown, instead of the texts sent from the c.i.e. for these alarms. These text messages will be downloaded to the unit via the c.i.e. A built-in buzzer will sound like in the c.i.e. The buzzer can be silenced and the alarm devices in the installation can be silenced. They will re-sound for a new alarm. When there are queued alarms in the system, you can scroll amongst them and they can be reset. Any fault in the system will be presented as "General fault in system" and the buzzer will sound.⁶⁶ A **Printer 1835** can be mounted in ext. FBP 1826. It will print all the alarms, including the user definable text messages. New S/W versions can be downloaded directly in the unit. The unit is power supplied from the c.i.e. or an ext. power supply. The unit can run as two **type** of units (i.e. in one of two S/W modes).

1826 in S/W mode 1826/28 - 1587 has the highest performance with regard to functionality, response time, ability to store fire alarms, etc. and is intended to succeed the ext. FBP 2426 (and 1826+printer 1835 will succeed the ext. FBP 2425) but not as spare parts, since 2425/26 requires an Ext. FBP interface board 1582 in the c.i.e. and 1826, in this S/W mode, requires an Ext. FBP / DU interface board 1587 in the c.i.e. The look, dimensions, etc. are not the same. EBL512 S/W version ≥ 2.2 is required.

1826 in S/W mode 1826/28 - 1582 has the same functionality as the ext. FBP 2426 and can be used as a spare part (and 1826+printer 1835 is a spare part for the ext. FBP 2425). Note, the performance is the same⁶⁷ but the look, dimensions, etc. are not the same. In this case an Ext. FBP interface board 1582 is required in the c.i.e.

The number of ext. FBPs that can be power supplied via the

⁶⁶ Not valid for the Swedish convention (SBF).

⁶⁷ **NOTE!** The alarm presentation will be like in the c.i.e. that ext. FBP is connected to, not as in 2425 / 2426. The 1826/28 front does not hold any LED "Zone/Detector not reset".

1587 / 1582 board (or an external power supply) is depending on if each 1826 unit has a printer or not, as well as all other units connected to the same board / external power supply.⁶⁸ Up to 1200 m cable can be used. For more information, see Technical description MEW00249.

1828 External Fire Brigade Panel (FBP). A compact size enclosure (HxWxD, 145 x 220 x 50 mm) made of grey high impact ABS. Fitted with a supplementary "O" ring gasket, it will comply with IP61, in respect of dust and moisture. The unit has no door, i.e. the front is accessed directly, when required. A key is required to get access to the push buttons and they are disabled until they are supposed to be used. The unit shall be wall mounted. Two compression glands are attached. In all other respects it is like 1826, except that a printer can not be mounted in 1828.

1828 in S/W mode 1826/28 – 1587 has the highest performance with regard to functionality, response time, ability to store fire alarms, etc. It is an alternative to the ext. Presentation display 2428, the Display unit 2236 and a compact size alternative to the ext. FBP 2426 but not as a spare part, since 1828, in this S/W mode, requires an Ext. FBP / DU interface board 1587 in the c.i.e. and the look, dimensions, etc. are not the same. EBL512 S/W version ≥ 2.2 is required.

1828 in S/W mode 1826/28 - 1582 is an alternative to the ext. Presentation display 2428, the Display unit 2236 and a compact size spare part to the ext. FBP 2426, i.e. the performance is the same⁶⁷ but the look, dimensions, etc. are not the same. 1828 in this S/W mode requires an Ext. FBP interface board 1582 in the c.i.e.

The number of ext. FBPs that can be power supplied via the 1587 / 1582 board (or an external power supply) is depending on all other units connected to the same board / external power supply.⁶⁸ Up to 1200 m cable can be used. For more information, see Technical description MEW00249.

1835 Printer. Can be mounted in the External Fire Brigade Panel **1826**. It will print all the alarms, including the user definable text messages.

2425 External Fire Brigade Panel with printer. No longer in stock.

2426 External Fire Brigade Panel without printer. No longer in stock.

⁶⁸ On each 1582 board are up to eight addresses available and on each 1587 board up to sixteen addresses.

9.4.2

External Presentation units

1728 External Presentation unit (EPU). A compact size enclosure (HxWxD, 145 x 220 x 50 mm) made of grey high impact ABS. Fitted with a supplementary "O" ring gasket, it will comply with IP61, in respect of dust and moisture. The unit has no door, i.e. the front is accessed directly, when required. The push buttons are disabled until they are supposed to be used. The unit shall be wall mounted. Two compression glands are attached. **The front's designation texts are in Swedish.** This unit is intended for pre-warning, co-occurrence⁶⁹, fire (and heavy smoke / heat) alarm presentation. If there are two or more alarms in the system, you can scroll amongst them but the fire alarms can not be reset via this unit.

All or selected alarms will be presented in a display (alphanumeric LCD, 2x40 characters), with back-light. A user definable text message will also be presented together with each alarm, if programmed in the c.i.e. Furthermore, at least 617 texts can for selected fire alarms be stored in the unit and will in such a case be shown, instead of the texts sent out from the c.i.e. for these alarms. These text messages will be downloaded to the unit via the c.i.e.

Any fault in the system will be presented in the display as "General fault in system". The buzzer will sound.⁶⁶ It can be silenced. Any disablement in the system will be presented as "General disablement in system".⁶⁶

A built-in buzzer will sound like in the c.i.e. The buzzer can be silenced but the alarm devices in the installation can not be silenced via this unit. New software versions can be downloaded directly in the unit. The unit is power supplied from the c.i.e. or an external power supply. The unit can run as two **type** of units (i.e. in one of two S/W modes). **1728 in S/W mode 1728 – 1587** has the highest performance with regard to functionality, response time, ability to store fire alarms, etc. and is intended to succeed the Display unit 2236 (with Swedish designation texts) but not as a spare part, since 2236 is connected to a COM loop and 1736, in this S/W mode, requires an Ext. FBP / DU interface board 1587 in the c.i.e.

1728 in S/W mode 1728 – 1582 is a spare part for the ext. Presentation Display 2428 (with Swedish designation texts). Note, the performance is the same but the look, dimensions, etc. are not the same. In this case an Ext. FBP interface board 1582 is required in the c.i.e.

The number of units that can be power supplied via the 1587 / 1582 board (or an external power supply) is depending on all other units connected to the same board / external power

⁶⁹ Two zone / address dependence.

supply.⁶⁸ Up to 1200 m cable can be used. For more information, see Technical description MEW00290.

2428 External Presentation Display. No longer in stock.

9.4.3

Data converters

Normally the ten first fire alarms will be sent out to the Data converter(s). To have all fire alarms sent out, see chapter "External Fire Brigade Panel (FBP) interface board 1582", page 29, jumper BY4.

2290 Data converter "BEST". No longer in stock.

2291 Data converter "TATECO". No longer in stock.

2292 Data converter "EBL Talk". No longer in stock.

Data converters are replaced by the Web-server 1588.

9.5

Alert Annunciation equipment

When the Alert Annunciation (AA) function shall be used in system EBL512, a unit is required for the related manoeuvres, i.e. to acknowledge / reset the AA alarms. For a detailed description of the Alert Annunciation function, see chapter "Alert annunciation", page 103.

1735 Alert Annunciation Unit (AAU). A compact size enclosure (HxWxD, 145 x 220 x 50 mm) made of grey high impact ABS. Fitted with a supplementary "O" ring gasket, it will comply with IP61, in respect of dust and moisture. The unit has no door, i.e. the front is accessed directly, when required. The push buttons are disabled until they are supposed to be used. The unit shall be wall mounted. Two compression glands are attached. **The front's designation texts are in Swedish.**

All or selected fire alarms will be presented in a display (alphanumeric LCD, 2x40 characters), with back-light. A user definable text message will also be presented together with each alarm, if programmed in the c.i.e. Furthermore, at least 617 texts can for selected fire alarms be stored in the unit and will in such a case be shown, instead of the texts sent out from the c.i.e. for these alarms. These text messages will be downloaded to the unit via the c.i.e. A built-in buzzer will sound to indicate a not acknowledged AA alarm.

New software versions can be downloaded directly in the unit. The unit is power supplied from the c.i.e. or an external power supply.

The unit has the following LEDs:

Fire and Alarms queued, indicating fire / AA alarm.

Operation, indicating that the unit is in operation, i.e. the **AA** function is enabled in the system. A time channel can be used to enable the **AA** function.

Fire brigade alerted, indicating that the "Fire brigade tx" output is activated in the c.i.e. because:

- the activated fire alarm is not an **AA** alarm
- the **AA** function has been ended, e.g. the acknowledge or investigation time has run out, etc.

Acknowledge, indicating that the **AA** alarm has been acknowledged.

The unit has the following push buttons:

Alarms queued, used to scroll amongst the alarms.

Acknowledge, used to acknowledge an **AA** alarm and hereby also silence the buzzer.

Reset, used to reset an **AA** alarm.

The unit can run in one S/W mode.

1735 in S/W mode 1735 – 1587 has high performance with regard to functionality, response time, ability to store alarms, etc. and is intended to succeed the Display unit with alert annunciation 2235 (with Swedish designation texts) but not as a pare part, since 2235 is connected to a COM loop and 1735 requires an Ext. FBP / DU interface board 1587 in the c.i.e. The number of units that can be power supplied via the 1587 board (or an external power supply) is depending on all other units connected to the same board / external power supply.⁶⁸ Up to 1200 m cable can be used. For more information, see Technical description MEW00224.

1736 Alert Annunciation Unit (AAU). This unit is like 1735, except it has a neutral front, where the **designation texts, in any language**, are made separately and by production put into a transparent "text slot" for the LED and push button respectively. (This front also holds one extra LED & two extra push buttons.).

The unit can run in one S/W mode.

1736 in S/W mode 1736 – 1587 has high performance with regard to functionality, response time, ability to store alarms, etc. and is intended to succeed the Display unit with alert annunciation 2235 (with designation texts in another language than Swedish) but not as a pare part, since 2235 is connected to a COM loop and 1736 requires an Ext. FBP / DU interface board 1587 in the c.i.e. The number of units that can be power supplied via the 1587 board (or an external power supply) is depending on all other units connected to the same board / external power supply.⁶⁸ Up to 1200 m cable can be used. For more information, see Technical description MEW00224.

1740 Alert Annunciation Controller (AAC). This unit shall be mounted close to the c.i.e. (or an ext. FBP / Presentation unit) where the fire alarms will be presented.

The unit has the following LEDs:

Fire, indicating fire / **AA** alarm.

Operation, indicating that the unit is in operation, i.e. the **AA** function is enabled in the system. A time channel can be used to enable this function.

Fire brigade alerted, indicating that the "Fire brigade tx" output is activated in the c.i.e. because:

- the activated fire alarm is not an **AA** alarm
- the **AA** function has been ended, e.g. the acknowledge or investigation time has run out, etc.

Acknowledge, indicating that the **AA** alarm has been acknowledged.

The unit has the following push buttons:

Acknowledge, used to acknowledge an **AA** alarm.

Reset, used to reset an **AA** alarm.

The compact size enclosure enclosure (HxWxD, 145 x 220 x 50 mm) is made of grey high impact ABS. Fitted with a supplementary "O" ring gasket, it will comply with IP61, in respect of dust and moisture. The unit has no door, i.e. the front is accessed directly, when required. The push buttons are disabled until they are supposed to be used. **The front's designation texts are in Swedish.**

The unit shall be wall mounted. The LED "Acknowledge" can be turned on by the push button "Acknowledge" or by an input, i.e. a programmable output in the c.i.e. This is set via a jumper "JP1" in the unit. The unit is power supplied from the c.i.e. or an external power supply. One supplementary compression gland can be used for cable entry.

Connections and more details are to be found in the Technical Description MEW00283.

9.6 Other units

NOTE! A unit marked grey (like this) = outgoing unit, not for new installations. Many of these units are no longer in stock. For information regarding these units see documentation for earlier S/W versions.

9.6.1 External (remote) indicators

2216 Ext. LED 2216 (ext. indicator). No longer in stock.

2217 Ext. LED 2217 (ext. indicator). Used when a detector is placed out of view or hidden. The LED is lit at the same time as the LED in the detector / base it is connected to. It has a "Burning house" symbol instead of text. 2217 can be connected to all types of Panasonic detectors / bases. The input is polarised; J1:1 (+5 to 24 V DC, 1 mA) / J1:2 (0 V). To be wall mounted with the attached frame (84 x 84 mm) or flush mounted, e.g. with a Swedish 65mm circular mounting box. 2217 is a spare part for the outgoing 2216.

9.6.2 Two inputs / one output unit 2222

Two inputs / one output unit 2222. No longer in stock.

9.6.3 Alarm devices (sounders, etc.)

In the Panasonic product range is no alarm devices intended for the supervised (monitored) voltage outputs in the control unit and/or COM loop output units. Connections of other alarm devices are to be according to dwg. 512-42 and -61.

Regarding addressable alarm devices, see page 50.

9.6.4 Door release magnets

In the Panasonic product range is no Door release magnets. It is recommended to connect such magnets to the special voltage output VO2 on the COM loop output unit 3364, see dwg. 512-63 and chapter "Output units (addressable)", page 48. Note the "protective diode" over the coil. Relay outputs (e.g. I/O unit 3361) with ext. power supply can also be used.

9.6.5 Boxes

3362 Waterproof box (IP66 / 67). A grey polycarbonate box with ingress protection rating IP66 / 67. Four compression glands are included for the cable entries. Dimensions (L x W x H): 175 x 125 x 75 mm. 3362 can be used for:

Addressable multipurpose I/O unit 3361

Addressable zone interface 2335

Addressable zone interface, isolated 2226

Addressable short circuit isolator 2370 / 4370.

9.6.6 Web-servers

1588 Web-server. A dark green plastic cabinet. Shall be vertically mounted on a symmetric 35 mm DIN rail (not supplied), outside and close (≤ 3 m) to an EBL512 c.i.e. 1588 has three functions. One, two or all three can be used.

1. **Web-server** Used when one or more EBL512 c.i.e:s shall be connected to Internet / an intranet (LAN), in order to present the actual status in a PC or Pocket-PC using the web browser Microsoft Internet Explorer. A *User name* and a *Password* may be used.

2. **E-mail client** Used to send an e-mail in case of fire alarm, pre-warning, fault, disablement / re-enablement, service signal and/or test mode.

3. **Gateway** One of the following gateway functions can be used in each 1588:

a. *EBL Talk*, used to transmit and present fire alarm information in a separate PC system. (Replacement for the Dataconverter 2292.)

b. *Tateco*, used to transmit and present fire alarm information in an Ascom Tateco paging system. (Replacement for the Data converter 2291.)

A PC tool, Web512 Config Tool **2.x.x**, is used for the configuration, which is downloaded to the web-server via TCP/IP.
NOTE! The Config Tool version and the EBL512 S/W version have to be the same.

The following interfaces are available:

PLC COM. (RS232C), to connect the web-server to an EBL512 c.i.e. via the supplied RS232 cable with a 9 ways female "D" connector.

Modem COM. (RS232C), a 9 ways male "D" connector, compatible to an IBM PC serial port, to connect the web-server to a modem, a separate PC system, etc. when the gateway function is used.

Ethernet COM. (10 BASE-T), an RJ45 connector for a standard Ethernet CAT.5 cable, to connect the web-server to Internet / an intranet (LAN).

Power supply, to connect the web-server to a power supply (EBL512 or external equipment). A 3 m cable with a plug-in connector (Molex 3.5) is supplied.

1588 will be replaced with Web-server 1598, see below.

1598 Web-server II. A light grey plastic cabinet (same size as 1588). Shall be vertically mounted on a symmetric 35 mm DIN rail (not supplied), outside and close (≤ 3 m) to an EBL512 c.i.e.

1598 will replace the Web-server 1588 (see above) as a spare part. In this case the PC tool, Web512 **II** Config Tool **2.x.x (1598)** is used for the configuration, which is downloaded to the web-server via TCP/IP.

NOTE! The Config Tool version and the EBL512 S/W version have to be the same.

1598 is not only a spare part for 1588. It has a bigger memory and extended possibilities / options. Also the site layout is updated. In this case the PC tool, Web512 **II** Config Tool **2.5.x** is used for the configuration, which is downloaded to the web-server via TCP/IP.

NOTE! The Config Tool version and the EBL512 S/W version have to be the same.

1598 has three functions. One, two or all three can be used.

1. Web-server with safe two-way communication:

EBL512 \leftrightarrow Web-server \leftarrow Internet / an intranet (LAN) \rightarrow PC.

a. Status information. Used when one or more EBL512 c.i.e:s shall be connected to Internet / an intranet (LAN), in order to present the actual status in a PC or Pocket-PC using the web browser Microsoft Internet Explorer. A *User name* and a *Password* may be used.

b. Manoeuvres. Used when one or more EBL512 c.i.e:s shall be connected to Internet / an intranet (LAN) for remote manoeuvres via a PC using the web browser Microsoft Internet Explorer. You can, among other things, perform the same

manoeuvres via a PC as you can do via the front in the EBL512 c.i.e. (disable / re-enable, acknowledge fault, etc.). A *User name* and a *Password* have to be used.

2. E-mail client Used to send an e-mail in case of fire alarm, pre-warning, fault, disablement, service signal and/or test mode.

3. Gateway One of the following gateway functions can be used in each 1588:

a. *EBL Talk*, used to transmit and present fire alarm information in a separate PC system. (Replacement for the Dataconverter 2292.)

b. *Tateco*, used to transmit and present fire alarm information in an Ascom Tateco paging system. (Replacement for the Data converter 2291.)

c. *SIA protocol*, used to transmit and present fire alarm information in a separate system (using the SIA protocol).

The following interfaces are available (same as on 1588):

PLC COM. (RS232C), to connect the web-server to an EBL512 c.i.e. via the supplied RS232 cable with a 9 ways female "D" connector.

Modem COM. (RS232C), a 9 ways male "D" connector, compatible to an IBM PC serial port, to connect the web-server to a modem, a separate PC system, etc. when the gateway function is used.

Ethernet COM. (10 BASE-T), an RJ45 connector for a standard Ethernet CAT.5 cable, to connect the web-server to Internet / an intranet (LAN).

Power supply, to connect the web-server to a power supply (EBL512 or external equipment). A 3 m cable with a plug-in connector (Molex 3.5) is supplied.

10 Programmable inputs

In each control unit are four programmable inputs (I0-I3) available. On the COM loops can be connected the addressable multi purpose I/O unit 3361 with two programmable inputs.

Each input is programmed (Win512) regarding:

- Logical name (Normally not changed, but used as Interlocking input it is recommended to add some identity information)
- Logic
- Triggered by ("Trigger condition")

The following depending on selected trigger condition:

- Fault number
- Fault text ("Fault message")
- Zone no. - Address
- Text ("Alarm text")
- Time channel no.
- Technical no.
- Output no.

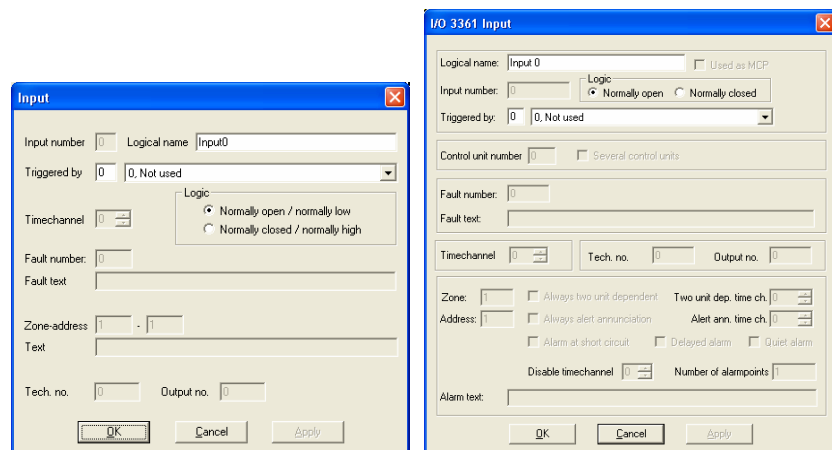

*Figure 9. Win512 "Input" dialog box. The different trigger conditions require different additional information.
NOTE! The 3361 unit, Input 0, has a special input dialog box.*

10.1 Control unit Inputs I0 - I3

Connections, see dwg. 512-43.

10.2 The 3361 unit's Inputs In0 / Z & In1

Connections, see dwg. 512-57.

NOTE! The monitored Input 0 can be used as a general input (In0) or used as a zone line input (Z)

11 Input programming

Input programming is done in Win512. For more information see Win512 help. Each input has to have an individual Trigger condition ("Triggered by") and Logic. It is not recommended to let two or more inputs have the same trigger condition.

11.1 Trigger conditions

The following trigger conditions are available:

0. **Not used**
1. **Alarm Key Cabinet** (one input per control unit)
2. **Alert Annunciation Acknowledge**
3. **Alert Annunciation Reset**
4. **Fault Signal External Power Supply** (one input per control unit)
5. **Fault Signal External Fuses** (one input per control unit)
6. **Time Channel 15 - 63** (one input per time channel per system)
7. **General Fire** (max. 127 per C.U.)
8. **Activated Routing Equipment** (one input per C.U.)
9. **Activated Extinguishing** (one input per C.U.)
10. **Activated Fire Ventilation** (one input per C.U.)
11. **External Fault** (50 inputs per system)
12. **Extinguishing start** ⁷⁰
13. **Extinguishing stop** ⁷⁰
14. **Interlocking input** (200 inputs per C.U. / 1000 per system)
15. **Loss of main power source to external power supply** (one input per C.U.)
16. **Loss of battery charger to external power supply** (one input per C.U.)
17. **Door Closing Test Input**
18. **Pre-warning Input** (input and corresponding fire alarm input "connected" to the same C.U.)
19. **Evacuate** (one input per C.U.)
20. **Activate output**
21. **Extinguishing alarm**
25. **Alarm from CU** ⁷¹
26. **Silence alarms**
99. **Zone Line Input** ⁷¹

⁷⁰ All inputs and outputs involved have to be connected to the same c.i.e.

⁷¹ Only valid for the Addressable multipurpose I/O unit 3361, Input 0, used as zone line input (Z).

Comments to the trigger conditions:

0. Default. The input does not work.
1. Key cabinet, where the fire brigade store there key to the building. Will activate a Key cabinet alarm. See EBL512 Operating Instructions for more information.
2. Alert annunciation, see EBL512 Operating Instructions for more information.
3. Like 2.
4. Ext. power supply equipment fault output will activate a fault in the EBL512 system. The following fault message will be shown:
FAULT: External power supply, CU xx
5. Ext. fuses (for the ext. power supply equipment) fault output will activate a fault in the EBL512 system. The following fault message will be shown:
FAULT: External fuses, control unit xx
6. External clock, timer, key switch, etc. can disable / re-enable alarm points. The function Alert Annunciation, etc. can be set on / off by a time channel. Control outputs can be set on / off by a time channel.
7. A special detector, push button, etc. can activate a fire alarm in EBL512. Zone no. and Address (+ user definable text).
8. Activated Fire brigade tx feedback to the EBL512 control unit to light up the LED "Fire brigade tx".⁷²
9. Activated Extinguishing equipment feedback to the EBL512 control unit to light up the LED "Extinguishing".⁷²
10. Activated Ventilation equipment feedback to the EBL512 control unit to light up the LED "Ventilation".⁷²
11. Ext. fault will activate a fault in EBL512. An user definable fault message ("Error text") up to 40 characters, will be shown.
12. Used to start a new "countdown", see 13 below.
Push button: NO, momentary action. One or more push buttons can be used.
13. Output for Extinguishing equipment (type of output = 2) has normally a delayed activation (a "countdown"). This "countdown" will be stopped when an input with trigger condition 13 is activated. To start a new "countdown", see 12 above.
Push button info: NO, latching action. One or more push buttons can be used. Manual reset of push button(s).
14. A feed-back from the equipment activated by the corresponding interlocking output. Activated input is shown in menu H9/C1. See also chapter "Interlocking function", page 88.

⁷² One input activated in any control unit, will light up the LED respectively in all control units.

15. "Loss of main power source to external power supply equipment" fault output will activate a fault in the EBL512 system. It will have the same time delay, as set for the Loss of main power source fault for the c.i.e. The following fault message will be shown:
FAULT: Mains, ext. power supply, CU xx
16. "Loss of the battery charger to external power supply equipment" fault output will activate a fault in the EBL512 system. It will have the same time delay, as set for the Loss of main power source fault for the c.i.e. The following fault message will be shown:
FAULT: Charging ext. power supply CU xx
17. When one or more "Fire door closing" outputs are used, these outputs will be activated for 20 seconds by this trigger condition.
NOTE! Only valid for inputs and outputs connected to the same c.i.e.
18. Pre-warning, e.g. from a High Sensitive Smoke Detector's pre-warning output. Zone no. and Address set to the same as the corresponding fire alarm (from the same detector).
19. A special New Zealand function. Key switch "Evacuation".
The function is like the push button "Evacuate" (P5) on the c.i.e. front.⁷³ The input has to be activated as long as the Evacuate function shall be on.
20. Activates any output as long as the input is active.
21. Input activated when the specified zone has activated fire alarm.
The specified zone is an "extinguishing zone", e.g. a sprinkler zone. This trigger condition is normally used only for the "New Zealand indicating panel" in order to control the function of the key switch "Silence alarms".
25. The Addressable multipurpose I/O unit 3361 monitored Input 0 used as zone line input (Z) for a single "slave" unit (control unit) or several control units connected in parallel, see chapter "Redundancy in distributed system", page 118.
26. A special New Zealand function. Key switch "Silence alarms".
Normal → *Active*: All alarm devices are silenced. (Same function as the "Silence alarm devices" on the c.i.e. front (FBP).
NOTE! The alarm devices will **not** be silenced if any input with trigger condition (no. 21) Extinguishing alarm is activated.
Active → *Normal*: All alarm points / zones in alarm status (i.e. activating fire alarm) will be "isolated" (disabled) and have to be re-enabled via menu H2/B5 (B4).
99. The Addressable multipurpose I/O unit 3361 monitored Input 0 used as zone line input (Z).

⁷³ Available in some conventions only.

11.2

Logic

The logic has to be set.⁷⁴

(•) **Normally open / normally low** Normally open contact or normally low optocoupler input.

() **Normally closed / normally high** Normally closed contact or normally high optocoupler input.

⁷⁴ In the Win512 dialog box "Input".

12 Programmable outputs

In each control unit are four programmable voltage outputs (S0-S3) and two programmable relay outputs (R0-R1) available. Up to six 8 relays expansion boards 1581 can be mounted in each control unit. On the COM loops can be connected Addressable Multi purpose I/O unit 3361 with two programmable relay outputs (Re0-Re1) per unit and Addressable 2 voltage outputs unit 3364. Addressable siren 3377 and Addressable sounder base 3378 can also be connected on the COM loops, i.e. the unit has no physical output but the siren and sounder respectively.

Each output is programmed (Win512), when applicable, regarding:

- Logical name (Normally not changed)
- Type
- Logic
- Voltage outputs: Supervised / Not Supervised
- Activation (time, delay, pulse, etc.)
- Control expression

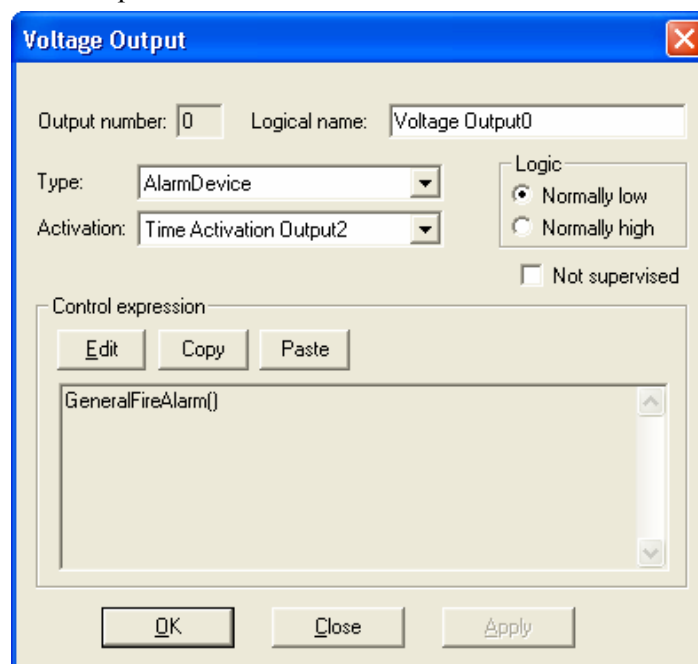

Figure 10. Win512 "Voltage Output" dialog box.

Each 3377 and 3378 unit is programmed (Win512) regarding:

- Technical number
- Logical name (Normally not changed)
- Priority level (High / Medium / Low)

- Sound type (Steady/continuous, Intermittent/pulsed or Alternating/two-tone)
- Output type (Normally "Alarm device")
- Activation (Steady/continuous, Steady delayed activation or Steady delayed de-activation)
- Control expression

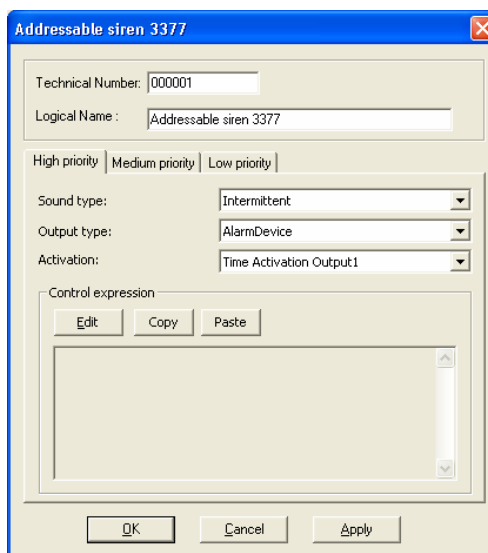

Figure 11. Win512 "Addressable siren 3377" (and "Addressable sounder base 3378") dialog box.

12.1 Control unit outputs S0 – S3

Each control unit has four programmable, supervised (monitored)⁷⁵ voltage outputs:

- S0 Supervised (monitored) voltage output, 24V DC
 - S1 Supervised (monitored) voltage output, 24V DC
 - S2 Supervised (monitored) voltage output, 24V DC
 - S3⁷⁶ Supervised (monitored) voltage output, 24V DC
- Connections and more information, see dwg. 512-42.

12.2 Control unit outputs R0 – R1

Each control unit has two programmable relay outputs:

- R0 Relay output, NO or NC contacts programmable
- R1 Relay output, NO or NC contacts programmable

⁷⁵ This is default, but via Win512 it is possible to set each output individually as not supervised (not monitored). A normally high output is not supervised. See also chapter "Calibration of supervised outputs", page 110.

⁷⁶ The supervised outputs normally have reverse polarity when not activated. In some configurations / conventions S3 has the same polarity activated as supervised, i.e. it should not be used for alarm devices (sounders).

Connections and more information, see dwg. 512-42.

12.3 **8 relays expansion board 1581 Output 0 – Output 7**

Each 1581 board has eight programmable relay outputs:

Output 0	Relay output, NO or NC contacts programmable
Output 1	Relay output, NO or NC contacts programmable
Output 2	Relay output, NO or NC contacts programmable
Output 3	Relay output, NO or NC contacts programmable
Output 4	Relay output, NO or NC contacts programmable
Output 5	Relay output, NO or NC contacts programmable
Output 6	Relay output, NO or NC contacts programmable
Output 7	Relay output, NO or NC contacts programmable

Connections and more information, see dwg. 512-47.

12.4 **German FBP interface board 1583 Output for extinguishing equipment**

The 1583 board⁷⁷ (max. one in each control unit) has one programmable output for activation of German extinguishing equipment. (VdS Standard-Schnittstelle "Löschen"; Löschbefehl).

Connections and more information, see dwg. 512-50.

12.5 **The 2262 / 2263 unit's Output 0 – Output 3**

This unit is no longer in stock.

Each 2262 / 2263 unit has four programmable, supervised (monitored) voltage outputs:

Output 0	Supervised (monitored) voltage output, 24V DC
Output 1	Supervised (monitored) voltage output, 24V DC
Output 2	Supervised (monitored) voltage output, 24V DC
Output 3	Supervised (monitored) voltage output, 24V DC

Each 2262 / 2263 unit also has two special outputs⁷⁸:

HOLD 1	Relay or voltage output, 24 V DC
HOLD 2	Relay or voltage output, 24 V DC

Connections and more information, see dwg. 512-61. See also chapter "Output units (addressable)", page 48.

⁷⁷ Can not be used in Swedish (SBF) convention.

⁷⁸ Designed for door release magnets, etc.

12.6 The 2265 unit's Output 0 – Output 3

This unit is no longer in stock.

Each 2265 unit has four programmable relay outputs:

Output 0 Relay output, NO-C-NC contacts

Output 1 Relay output, NO-C-NC contacts

Output 2 Relay output, NO-C-NC contacts

Output 3 Relay output, NO-C-NC contacts

Connections and more information, see dwg. 512-61.

12.7 The 3361 unit's Output Re0 – Re1

Each 3361 unit has two programmable relay outputs:

Re0 Relay output, NO or NC contacts programmable

Re1 Relay output, NO or NC contacts programmable

Connections and more information, see dwg. 512-53 & -57.

12.8 The 3364 unit's VO0 – VO2

Each 3364 unit has two programmable, supervised (monitored)⁷⁵ voltage outputs:

Output VO0 Supervised (monitored) voltage output, 24V DC⁷⁹

Output VO1 Supervised (monitored) voltage output, 24V DC⁷⁹

Each 3364 unit also has one programmable special output, intended for fire door closing (release magnets):

Output VO2 Voltage output, 24 V DC⁷⁹ (normally high)

Connections and more information, see dwg. 512-53 & -63.

12.9 The 3377 unit's Output (siren)

Each 3377 unit has one programmable output:

Output Siren, with three priority levels and three types of tones.

Connections and more information, see dwg. 512-53.

12.10 The 3378 unit's Output (sounder)

Each 3378 unit has one programmable output:

Output Sounder, with three priority levels and three types of tones.

Connections and more information, see dwg. 512-53.

⁷⁹ Cont. 1 A, during 10 ms 1.4 A.

13 Output programming

Output programming is done in Win512. See the Win512 dialog box respectively. For more information see also Win512 help.

13.1 Type of output

Some output types can be collectively disabled and when activated, an LED will indicate it. The following types are available:

0. **Control**
1. **Fire Ventilation**
2. **Extinguishing**
3. **Alarm Device**
4. **Routing Equipment (Fire brigade tx)**
5. **Control, neutral**
6. **Interlocking Output**

Comments to the output types:

0. Default. General (normal) control output⁸⁰
1. Used to activate fire ventilation equipment⁸¹
2. Used to activate extinguishing equipment⁸²
3. Used for sounders, etc.⁸³
4. Used for **fire brigade tx** outputs⁸⁴
5. The outputs will not be collectively disabled and not indicated by any LED.

⁸⁰ Controlled by menu H2/B8 Disable / Re-enable all control, extinguishing and ventilation outputs.

⁸¹ Controlled by menu H2/B8 Disable / Re-enable all control, extinguishing and ventilation outputs. When activated, the LED "Ventilation" indicates it. (Feedback from the fire ventilation equipment to a programmable input can light up the LED instead).

⁸² Controlled by menu H2/B8 Disable / Re-enable all control, extinguishing and ventilation outputs. When activated, the LED "Extinguishing" indicates it. (Feedback from the extinguishing equipment to a programmable input can light up the LED instead).

⁸³ Controlled by menu H2/B9 Disable / Re-enable Alarm devices and by push button "Silence alarm devices". Output fault / disablement is indicated by LED **Fault / Disablements** "Alarm devices" blinking / continuous.

⁸⁴ Activated according to its control expression. Disabled like the standard control unit "Fire brigade tx" relay output. When activated, the LED "Fire brigade tx" indicates it. (Feedback from the Fire brigade tx to a programmable input can light up the LED instead). Output fault / disablement is indicated by LED **Fault / Disablements** "Fire brigade tx" blinking / continuous.

NOTE! When the Alert Annunciation function shall be used the following trigger condition has to be added to the control expression: **&!Alert Annunciation activated** (no. 29).

6. This output can be used together with a corresponding interlocking input. See chapter "Interlocking function", page 88. Activated output is shown in menu H9/C1.

13.2 Logic

(•) **Normally open / low** Normally open relay contact or normally low voltage output.⁸⁵

() **Normally closed / high** Normally closed relay contact or normally high voltage output (24V DC).⁸⁶

13.3 Not supervised

A voltage output is supervised (default). By marking this checkbox the voltage output will be not supervised. (A normally high output can not be supervised.)

13.4 Time activation

"Time Activation Output" types (1-10) can be programmed regarding:

- Type (0-6)
- Delay time (when required)
- Pulse length (when required)
- Pulse off (when required)
- De-activation (when required)

The following Time activation output types are available:

0. Steady (continuous)
1. Intermittent
2. One pulse
3. Steady Delayed Activation
4. Intermittent Delayed Activation
5. One pulse Delayed Activation
6. Steady Delayed De-Activation

Regarding the programming, see chapter "Time activation output", page 140.

⁸⁵ The logic is set in the Win512 dialog box "Voltage / Relayed Output".

⁸⁶ The logic is set in the Win512 dialog box "Voltage / Relayed Output".

NOTE! A normally high output can not be supervised and it will be low for a few seconds during restart of the c.i.e.

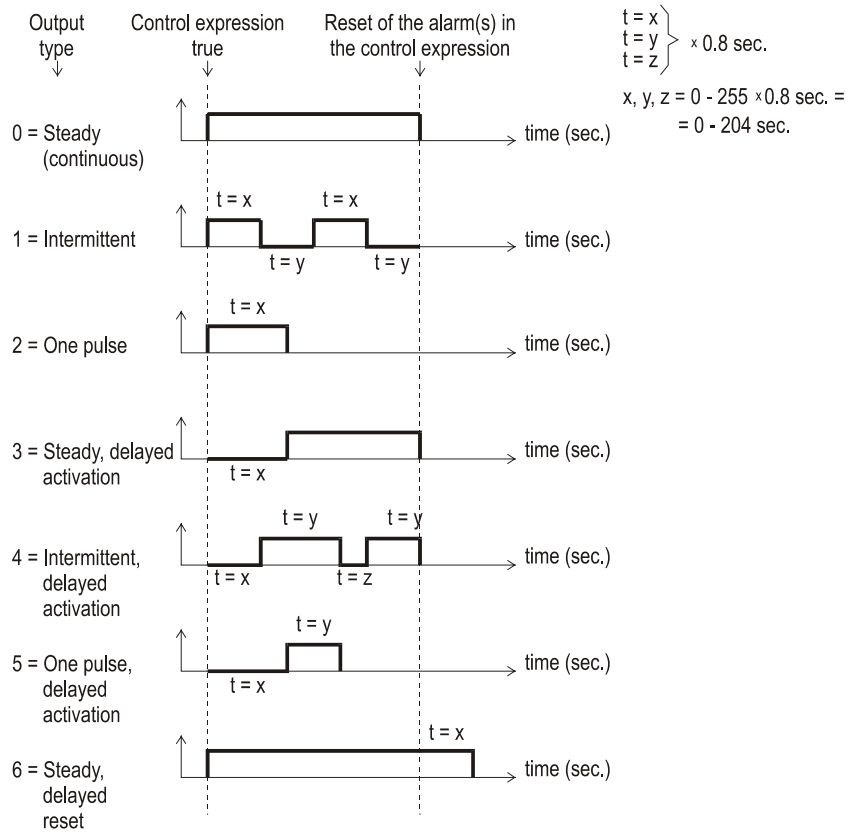

Figure 12. Delay time, Pulse length, Pulse off and/or De-Activation, have to be set for the type respectively.

NOTE! The different types can be used together with the different outputs according to the following table:

Output Type	In the Control Unit				COM loop unit				Inter-locking
	S0 - S3	R0 - R1	1581 Board	1583 Board	2265	2262 2263 3364	3361	3377 3378	
0 Steady (cont.)	X	X	X	X	X	X	X	X	X
1 Intermittent	X	X	--	--	--	XX	--	--	--
2 One pulse	X	X	--	--	--	--	--	--	--
3 Steady delayed	X	X	X	--	X	X	X	X	X
4 Interm. delayed	X	X	--	--	--	XX	--	--	--
5 One pulse del.	X	X	--	--	--	--	--	--	--
6 Steady del. reset	X	X	X	--	X	X	X	X	--

Figure 13. Programmable outputs in relation to Time Activation Output type. X = Output type is selectable. XX = Output type is selectable but only for intermittent 0.8 / 0.8 sec. NOTE! 1583 board not in Swedish (SBF) convention.

13.5 Control expression

Each programmable output has to be given a control expression. It is made by so called Boolean algebra.

Trigger conditions (see "Available functions"), logical "Operators" (**AND**, **OR**, **NOT**) and parentheses are used to make a "control expression" containing up to 40 trigger conditions. See also chapter "Control expression examples" page 84, and Win512 help.

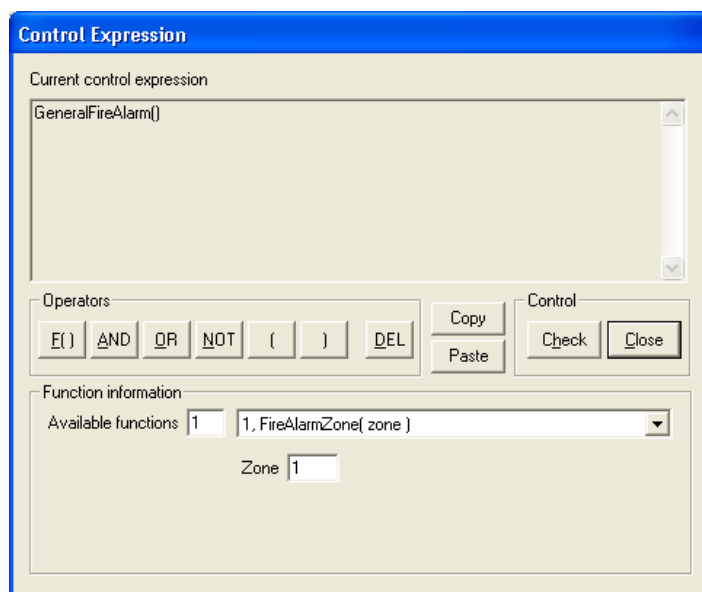

Figure 14. Win512 "Control Expression" dialog box. Note! The number and type of fields in the "Function information" part of the box vary depending on the "Available function" selected.

13.5.1 Trigger conditions

Some trigger conditions (see "Available functions") require additional information, see information within parentheses (+nnnnn) after the trigger conditions below.

Some trigger conditions include a sequence. "Quantity" (1-10, default "1") shows the number of alarm points within the sequence that have to be activated to fulfil the trigger condition.

The following trigger conditions are available:

- 1 **Fire Alarm Zone** (+Zone no.)
- 2 **Fire Alarm Zone Address** (+Zone no.+Address)
- 3 **General Fire Alarm**
- 4 **Consecutive Fire Alarm** (sequence) (+start Zone no. and address +stop Zone no. and address +Quantity)
- 5 **Pre Warning Zone** (+Zone no.)
- 6 **Pre Warning Zone Address** (+Zone no.+Address)
- 7 **General Pre Warning**
- 8 **Consecutive Pre Warning** (+start Zone no. and address +stop Zone no. and address +Quantity)
- 9 **Heavy Smoke Alarm Zone** (+Zone no.)

-
- 10 **Heavy Smoke Alarm Zone Address** (+Zone no.+Address)
 - 11 **General Heavy Smoke Alarm**
 - 12 **Consecutive Heavy Smoke Alarm** (sequence) (+start Zone no. and address +stop Zone no. and address +Quantity)
 - 13 **Two Address Dependent Fire Alarm** (+Zone no. +Address)
 - 14 **Two Zone Dependent Fire Alarm** (+Zone no.)
 - 15 **Interlocking Input Area Activated** (+Area no.)
 - 16 **Interlocking Input Area Point Activated** (+Area no. +Point)
 - 17 **General Interlocking Input Activated**
 - 18 **Consecutive Interlocking Input Activated** (sequence) (+start Area no. and point +stop Area no. and point +Quantity)
 - 19 **Fire Brigade Tx Activated**
 - 20 **Fault Tx Activated**
 - 21 **Fire Brigade Tx Disabled**
 - 22 **Zone Disabled** (+Zone no.)
 - 23 **Zone Address Disabled** (+Zone no. +Address)
 - 24 **General Zone Address Disabled**
 - 25 **General Fault**
 - 26 **General Charge Fault**
 - 27 **Reset Pulse Zone Address** (+Zone no. +Address)⁸⁷
 - 28 **Time Channel Activated** (+Time channel no.)
 - 29 **Alert Annunciation Activated**
 - 30 **Alert Annunciation Acknowledged**
 - 31 **Door Open** (+Control unit)
 - 32 **General Door Open**
 - 33 **Key Cabinet Open**
 - 34 **General Control Disabled**
 - 35 **Control Disabled** (+Control unit)
 - 36 **General Alarm Device Disabled**
 - 37 **Alarm Device Disabled** (+Control unit)
 - 38 **Fire Door Closing** (+Zone no. +Address)
 - 39 **General Service Signal**
 - 40 **General Encapsulated**⁸⁸
 - 41 **AAF Zone Alarm** (+AAF zone no.)
 - 42 **Quiet Alarm Zone** (+Zone no.)
 - 43 **Quiet Alarm Zone Address** (+ Zone no. +Address)

⁸⁷ Only valid for the c.i.e. outputs (S0-S3, R0 and R1), 1581 outputs and 3361 outputs.

⁸⁸ Not valid any more. This trigger condition will never be true.

Comments to the trigger conditions (functions):

- 1 Fire alarm. For more information, see EBL512 Operating Instructions.
- 2 See 1.
- 3 See 1.
- 4 See 1.
- 5 Pre-warning.⁸⁹ For more information, see EBL512 Operating Instructions.
- 6 See 5.
- 7 See 5.
- 8 See 5.
- 9 Heavy smoke / heat alarm. For more information, see EBL512 Operating Instructions.
- 10 See 9.
- 11 See 9.
- 12 See 9.
- 13 One address (in two-address dependence) is in fire alarm state. For more information, see EBL512 Operating Instructions.
- 14 One zone (in two-zone dependence) is in fire alarm state. For more information, see EBL512 Operating Instructions.
- 15 One or more interlocking inputs, in the specified interlocking area, are activated.
- 16 The interlocking input, in the specified interlocking area/point, is activated.
- 17 One or more interlocking inputs are activated.
- 18 One or more interlocking inputs, in the specified range, are activated (from interlocking area no./point to interlocking area no./point).
- 19 Routing equipment output (any Fire brigade tx output) is activated.⁹⁰
- 20 Routing equipment output (Fault tx) is activated.⁹¹
- 21 Routing equipment output (Fire brigade tx) is disabled.⁹²
- 22 The specified zone is disabled.
- 23 The specified alarm point (zone/address) is disabled.

⁸⁹ The trigger condition is true as long as the pre-warning level is exceeded. It is also true as long as the fire alarm level is exceeded even if the option pre-warning detection is disabled (via Win512).

⁹⁰ Indicated by LED "Fire brigade tx". Output can be tested via menu H1. This trigger condition shall not be used for type of output 4 = Routing equipment.

⁹¹ Indicated by LED "Fault tx activated". Output can be tested via menu H1.

⁹² Indicated by LED "**Fault/Disablements** Fire brigade tx".

- 24 One or more alarm points (zone/address) are disabled.⁹⁵
- 25 One or more faults are generated in the system.⁹³
- 26 Loss of mains (in a c.i.e. or output unit 2262). **NOTE!**
The output(s) will be activated immediately but the corresponding fault is normally delayed.
- 27 This control expression is true for 5 seconds, whenever a reset pulse is sent to the specified zone/address. The control expression can only be used in the same c.i.e. as the specified zone/address.
- 28 The programmed time channel (1-63) is activated.
- 29 Alert annunciation activated (by any alarm point set to activate this function). For more information, see EBL512 Operating Instructions.
- 30 Alert annunciation activated (by any alarm point set to activate this function) and acknowledged. For more information, see EBL512 Operating Instructions.
- 31 Door open in the specific control unit.⁹⁴
- 32 Door open in any control unit in the system.⁹⁴
- 33 Key cabinet alarm. For more information, see EBL512 Operating Instructions.
- 34 General control disabled (via menu H2/B8).⁹⁵
- 35 Control disabled for a specific control unit (via menu H2/B8).⁹⁵
- 36 General alarm device disabled (via menu H2/B9⁹⁶ or via "Silence alarm devices).
- 37 Alarm device disabled for the specific control unit (via menu H2/B9 or via "Silence alarm devices).
- 38 This trigger condition plus the OR operator shall be used for each detector (zone-address) controlling a fire door (normally \geq two detectors). Type of output is normally "Control, neutral".⁹⁷ See also chapter "Fire Door Closing", page 92.
- 39 Service signal is activated (by any sensor).⁹⁸
- 40 Due to revised encapsulation function this trigger condition has no function. (It will never be true.)
- 41 **AAF zone** is used for the **Alarm Acknowledgement Facility** in conjunction with the AAF Control, which is available on the Australian market only.

⁹³ Indicated by LED "General fault" and/or LED "Fault tx activated".

⁹⁴ Or ext FBP:s connected to the control unit(s).
Indicated by LED "Door open".

⁹⁵ Indicated by LED "Disablements".

⁹⁶ Indicated by LED "**Fault / Disablements** Alarm devices".

⁹⁷ In Danish convention (DBI), must only the c.i.e. outputs R0-R1 and S0-S3 be used. (No COM loop units.) and the type has to be "control. neutral".

⁹⁸ Indicated by LED "Service".

42 Any "Quiet alarm" in the specified zone. Used e.g. for the fan control function.

43 One specified "Quiet alarm" in the specified zone. Used e.g. for the fan control function.

13.5.2 Logical operators

The logical operators available in Win512 are in priority order:

() **parentheses**, changes priority order

NOT **not**-function (inverts), is written **!** in Win512

AND **and**-function, is written **&&** in Win512

OR **or**-function, is written **||** in Win512

13.5.3 Control expression examples

In order to understand the possibilities to create control expressions, here follow some AND, OR, NOT and () examples and also some control expression examples.

13.5.3.1 AND

$a \&\&b \&\&c = y$

y is true (=1) when all the conditions **a**, **b**, **c** are true, i.e. a=1 and b=1 and c=1 makes y=1. All other combinations makes y=0.

This is also shown in the following table:

a	b	c	y
0	0	0	0
0	0	1	0
0	1	0	0
0	1	1	0
1	0	0	0
1	0	1	0
1	1	0	0
1	1	1	1

13.5.3.2 OR

$a | b | c = y$

y is true if at least one of the conditions **a**, **b**, **c** is true, i.e. a=1 or b=1 or c=1 makes y=1.

This is also shown in the following table:

a	b	c	y
---	---	---	---

0	0	0	0
0	0	1	1
0	1	0	1
0	1	1	1
1	0	0	1
1	0	1	1
1	1	0	1
1	1	1	1

13.5.3.3**NOT**

Inverts a condition, e.g. $!b=1=1$.

$a | !b \& \& c = y$

This is shown in the following table:

a	b	c	y
0	0	0	0
0	0	1	1
0	1	0	0
0	1	1	0
1	0	0	1
1	0	1	1
1	1	0	1
1	1	1	1

13.5.3.4**Parentheses**

Changes priority order.

$a | !(b \& \& c) = y$ (This is same as the previous but completed with parentheses.)

This is shown in the following table:

a	b	c	y
0	0	0	1
0	0	1	1
0	1	0	1
0	1	1	0
1	0	0	1
1	0	1	1
1	1	0	1
1	1	1	1

13.5.3.5**Control expressions**

The AND operator has priority, i.e. $a \& \& b | | c = (a \& \& b) | | c$. This is perhaps more obvious if you write it: $a \cdot b + c$.

This means that: $a \& \& b | | c \neq a \& \& (b | | c)$.

Here follows some examples (and explanations) to show the principles how to build a control expression with "conditions" and logical operators.):

Example 1

Output: Voltage output **S0**
Control expression: Pre Alarm Zone (90)
Explanation: Pre-warning activated in zone no. 90 will activate the output S0.

Example 2

Output: Relay output **R1**
Control expression: General Control Off () && !Door Open (01)
Explanation: Controls OFF (via menu H2/B8) will activate the output R1 when the door in control unit 01 is not open (i.e. closed).

Example 3

Output: Relay output **R0**
Control expression: Fire Alarm Zone (145) && Fire Alarm Zone (045) && General Fault ()
Explanation: Fire alarm activated in zone 145 and zone 45 will activate the output R0 when there are one ore more faults in the system at the same time.

Example 4

Output: Voltage output **S1**
Control expression: Consecutive Fire Alarm (100,10,100,19,1) || Consecutive Fire Alarm (100,21,100,40,1)
Explanation: Fire alarm activated by one of the alarm points in zone 100 address 10-19 or activated by one of the alarm points in zone 100 address 21-40 will activate the output S1 (i.e. alarm point address 20 in zone 100 will not activate the output S1).

14 Interlocking function

The interlocking function is used to verify that an output really is activated, i.e. by "combining" an output with an input (feed-back from the equipment controlled by the corresponding interlocking output).

14.1 Programming of interlocking function

Win512 is used for the programming. Up to 200 Interlocking Combinations per c.i.e. can be used and up to 1000 in a system.

NOTE! One Interlocking Combination (the input, the output and the area) has to be in / connected to one c.i.e. An input and an output can only be used in one combination.

14.1.1 Interlocking output

The "Voltage Output" / "Relay Output" dialog boxes are to be used.

Type: "Interlocking" is to be selected.

Activation ("Time Activation Output"): Type 0 = Steady (continuous) or Type 3 = Steady, delayed activation is to be selected (checked by the "Validate" function in Win512).

Control Expression is to be programmed for the output, i.e. for the equipment to be controlled.

Activated output will be indicated in menu H9/C1.

Logical Name: It is recommended to add the interlocking combination's presentation number (Area-Point).

14.1.2 Interlocking input

The "Input" dialog box is to be used.

Triggered by alternative 14 = Interlocking Input, is to be selected.

Activated input will be indicated in menu H9/C1.

Logical Name: It is recommended to add the interlocking combination's presentation number (Area-Point).

14.1.3 Interlocking combination

An interlocking output and an interlocking input are programmed in an interlocking combination to get the interlocking functions.

NOTE!

The interlocking outputs and inputs have to be programmed before the programming of an interlocking combination is possible to do.⁹⁹

(An interlocking combination can have only an output or only an input programmed, e.g. when a user definable text message is wanted to indicate an activated output or input.)

⁹⁹ In the "Interlocking Combination" dialog box are listed all the outputs and inputs previous programmed for interlocking, see Figure 15.

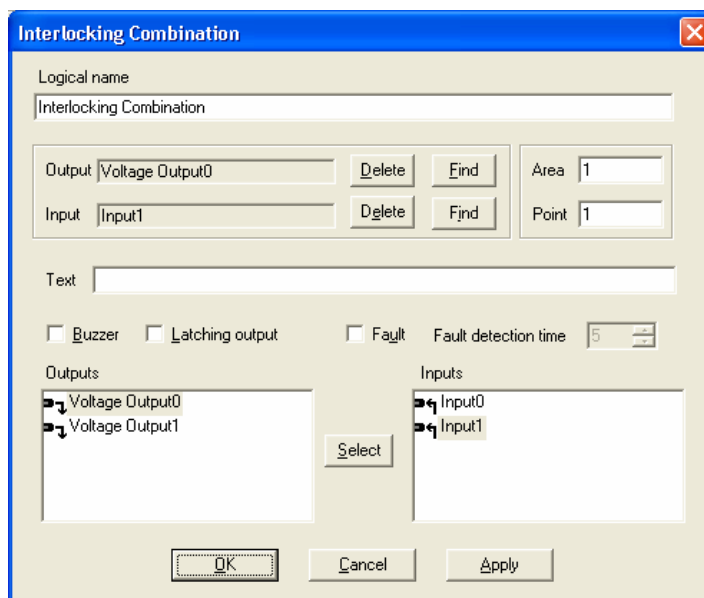

Figure 15. Win512 "Interlocking Combination" dialog box.

Logical Name: Displayed in the Win512 Tree and List views. Default is "Interlocking Combination" that can be changed when wanted / required. "Area-Point" will be added in the tree view. "Area-Point" will be shown under "Zone-Address" in the list view.

The **Outputs** list displays all the previous programmed outputs, Type = "Interlocking Output".

The **Inputs** list displays all the previous programmed inputs with the Triggered by alternative (trigger condition) 14 = "Interlocking Input". Select one **Output** and one **Input**. Press **Select** and the selected output and input will be shown in the **Output** and **Input** field respectively.

It is possible to **Delete** an output / input (from the field) and to **Find** (go to) the output / input dialog box respectively¹⁰⁰.

Area and Point: Each "Interlocking Combination" is presented as Area-Point (compare with Zone-Address). Area numbers 1-999 are possible and within each Area, Point numbers 1-99 are possible to use. An Area can only be used in one c.i.e.

Text = User definable text message to be shown in the menu H9/C1. Can be written in this field or in the "Texts" dialog box, see chapter "Creating the user definable text messages via Win512", page 113.

Buzzer checked = activated interlocking input will turn on the c.i.e. buzzer (0.8 / 0.8 sec.)¹⁰¹. The buzzer can be silenced. It will be automatically turned on again, if a new interlocking input is activated.

¹⁰⁰ The output / input respectively will also be "selected" (high-lighted) in the tree and list views.

¹⁰¹ Priority order: Fire alarm – Pre-warning - Interlocking - Fault.

Latching output checked = Output reset has to be performed via menu H9/C3. (Automatically output reset will not take place when the control expression becomes false.)

Fault checked = Fault detection ON.

Fault Detection Time: If the input is not activated within 5-255 seconds after the output is activated¹⁰², a fault will be generated:

```
FAULT: Interlocking input AAA/PP
Date: MM-DD   Time: HH:MM
```

14.2 Interlocking indications

One or more activated Interlocking Combinations (interlocking output and/or input) are indicated in the alphanumeric display in the c.i.e.¹⁰³:

```
Interlocking input/output activated
See menu H9/C1
```

Disabled interlocking output is indicated by the LED "Disablesments".

14.3 Information of interlocking combinations (H9)

Menu H9 has the following sub menus.

14.3.1 Display interlocking information (H9/C1)

See also chapter "Interlocking indications", page 90.

In menu H9/C1 will information be shown as follows:

```
Output AAA/PP activated at HH:MM
User definable text message.. . . .
```

OR

```
Output AAA/PP act HH:MM, input act HH:MM
User definable text message.. . . .
```

OR

```
Input AAA/PP activated at HH:MM
User definable text message.. . . .
```

AAA = Interlocking combination Area

PP = Interlocking combination Point within the Area

HH = Hours

MM = Minutes

Use "↑" "↓" to scroll between several interlocking combinations.

¹⁰² After the end of the delay time (if used).

¹⁰³ This indication has the lowest priority and will only be shown if the display was empty.

14.3.2 **Activate interlocking output (H9/C2)**

Even if the control expression for an interlocking output is not fulfilled (true), the output can be manually activated via this menu.

The "Interlocking Combination" (Area / Point) is to be entered to activate the output. The corresponding interlocking input will be "monitored" in the same way as if the output was activated by its control expression.

Reset has to be performed via menu H9/C3.

14.3.3 **Reset interlocking output (H9/C3)**

Activated interlocking outputs are listed here. Use "↑" "↓" to scroll between the "Interlocking Combinations" (Area / Point).

Interlocking output activated via its control expression and latching output selected: The output has to be reset via this menu.

Interlocking output activated via its control expression and latching output not selected: The output can be reset via this menu.

Interlocking output activated via menu H9/C2: The output has to be reset via this menu.

14.3.4 **Disable interlocking output (H9/C4)**

Interlocking outputs (i.e. Output Type = Interlocking) can be disabled via menu H9/C4. **NOTE!** Not via menu H2/B3. A disabled output will stay in (or return to) the normal condition for the output respectively. The "Interlocking Combination" (i.e. Area / Point) is to be entered to disable the output.

If "000/00" is entered, all interlocking outputs in the system will be disabled.

14.3.5 **Re-enable interlocking output (H9/C5)**

Interlocking outputs (i.e. Output Type = Interlocking) can be re-enabled via menu H9/C5. **NOTE!** Not via menu H2/B6.

Disabled interlocking outputs are listed in menu H9/C5. Use "↑" "↓" to scroll between the "Interlocking Combinations" (i.e. Area / Point) or type it via the key-pad.

If "000/00" is entered, all interlocking outputs, disabled via menu H9/C4 and "000/00", will be re-enabled.

14.4 **Interlocking control expressions**

A programmable output control expression can contain "interlocking" trigger conditions ("Functions") numbers 15-18 (see chapter "Control expression", page 80), i.e. one or more outputs can be activated when one or more interlocking inputs are activated.

15 Fire Door Closing

Programmable outputs¹⁰⁴ can be used for fire door closing. A special trigger condition is available (no. 38 = Fire Door Closing.). Type of output is normally "Control, neutral". One or more alarm points can control the output, i.e. the detectors on both sides of the fire door. **NOTE!** The alarm points and their "belonging" output have to be in / connected to the same c.i.e.

In case of one of the following "events", the output will be activated, i.e. the fire door will be closed:

- Fire alarm (any of the programmed detectors)
- Fire alarm in "Test mode" (any of the programmed detectors)
- Fault (i.e. "no answer" from any of the programmed detectors¹⁰⁵)
- Disablement (any of the programmed detectors, the involved zone(s) or the involved COM loop)¹⁰⁶
- A definite time every day, if programmed via Win512. The output will be activated for 20 seconds.
- Via a programmable input (trigger condition no. 17 = Door Closing Test Input). The output will be activated for 20 seconds.

NOTE!

BS4 loops / detectors and DET8 (1580) zone line inputs can not be used for this type of Fire Door Closing.

If a magnet contact is available, is it possible to get a "closed fire door verification" via the Interlocking function. In this case, Type of output has to be "Interlocking output". See also chapter "Interlocking function", page 88.

¹⁰⁴ In the DBI (Danish) convention, must only the c.i.e. outputs R0-R1 and S0-S3 be used and "Type of output" has to be "Control, neutral".

¹⁰⁵ E.g. if the detector is faulty, if there are two breaks or short-circuit on the COM loop.

¹⁰⁶ If an I/O unit 3361 (output) is used, it should, for safety reasons be connected to another COM loop than the "belonging" detectors.

16 Functions / Services / Features

Some Functions / Services / Features require programming in Win512, see chapter "PC S/W", page 18. For more information see also EBL512 Operating Instructions and Win512 help.

How to connect the PC and more information, see EBL512 Operating Instructions chapter "Programming (SSD download)", "New system program (S/W) version download" and "EBL512 settings download".

16.1 Sensor value

An analog detector is like a "sensor". It detects the environment and the analog values are converted to digital values, "sensor values", which are continuously picked up and evaluated by the control unit (c.i.e.) for each detector individually.

16.2 Week average sensor value

A week average sensor value is calculated for each analog smoke detector individually, see chapter "Analog smoke detector", page 111. Regarding the analog smoke detectors **33xx** and **430x**, a **decision value** (see below) instead of a sensor value, is stored each hour.

16.3 Decision value

The decision value¹⁰⁷ is used to decide if it is normal state, pre-warning, fire alarm or heavy smoke alarm and in the smouldering smoke algorithm (see page 97). The decision value is calculated, see chapter "Filtering algorithm, page 95.

16.4 Alarm algorithms for smoke detectors / Detection levels / Offsets

The following is valid for the analog smoke detector types **33xx** / **430x** in **NORMAL mode** (= OPT3304 / AMD3316 in Win512).

It is also valid for the analog smoke detector types **2200** (ION2200 in Win512), **2202** (OPT2202 in Win512), **2300** (ION2300 in Win512), **2304** (OPT2304 in Win512), **3304** / **430x** in **2312 mode** (= OPT2304 in Win512) and Autronica analog smoke detectors¹⁰⁸ (AUT SENSOR in Win512).

Each detector type has an alarm algorithm and each detector type has three detection levels:

¹⁰⁷ Like the sensor value for 22xx and 23xx analog detectors.

¹⁰⁸ Connected to a BS4 loop, i.e. an Autronica interface board 1584 is required in the c.i.e.

1. **fire alarm**¹⁰⁹
2. **pre-warning** will be activated (if selected in Win512, for each control unit) at a lower level (smaller offset) than for fire alarm, i.e. pre-warning will be activated before fire alarm will be activated.
3. **heavy smoke alarm** will be activated at a higher level (bigger offset) than for fire alarm, i.e. heavy smoke alarm will be activated after fire alarm will be activated.

The pre-warning offset and the heavy smoke alarm level can, for the whole system, be set in Win512, see chapter "Alarm algorithms", page 142. See also Win512 help.

The fire alarm offset can, for the whole system, be set in Win512, see chapter "Alarm algorithms", page 142. See also Win512 help.

NOTE! This is not a normal action and a special password is required. "Pre-warning", "Fire Alarm" and "Heavy Smoke Alarm" can activate programmable outputs respectively, see chapter "Control expression", page 80. See also EBL512 Operating Instructions.

16.4.1

Alarm algorithm / Alternative alarm algorithm

The following is valid only for the analog smoke detector types **33xx** and **430x** in **NORMAL mode** (=3304 OPT / 3316 AMD in Win512).

In order to reduce the nuisance alarms¹¹⁰ and ensure that the real fire alarms will be activated, six different alarm algorithms are available. See Figure 16., page 96. They are based on:

- Normal (N), high (H) or low (L) sensitivity
- Normal (15 sec.) or slow (35 sec.) detection time

Normal sensitivity (Default) Approx. **3.0 %** smoke obscuration per meter is required to activate fire alarm.

High sensitivity Approx. **2.4 %** smoke obscuration per meter is required to activate fire alarm, i.e. less than for normal sensitivity. Can be used when an "early" fire alarm is required.

Low sensitivity Approx. **3.6 %** smoke obscuration per meter is required to activate fire alarm, i.e. more than for normal sensitivity. Can be used to reduce nuisance alarms¹¹⁰ but might not fulfil the EN54-7 specifications.

Normal detection time (15 sec.) (Default) If it was possible to fill a detector with smoke within 1 sec. there is nevertheless min. 15

¹⁰⁹ The fire alarm level for each analog detector (sensor) = the current week average sensor value + a fixed fire alarm offset (value), i.e. when the current week average sensor value is re-calculated (and adjusted) the fire alarm level will also be adjusted. The detector's sensitivity is accordingly constant.

¹¹⁰ So called false / unnecessary alarms.

seconds alarm delay. This is a "normal filter" to reduce nuisance alarms.

Slow detection time (35 sec.). If it was possible to fill a detector with smoke within 1 sec. there is nevertheless min. 35 seconds alarm delay. This is an "extra filter" to reduce nuisance alarms¹¹⁰ but might not fulfil the EN54-7 specifications.

Each analog smoke detector can have two alarm algorithms programmed (via Win512). One **alarm algorithm** that is normally used (**N-15** is default) and one **alternative alarm algorithm** that is used when a time channel (internal or external) is activated. E.g. normal sensitivity can be used in the night-time and low sensitivity can be used in the daytime (i.e. the alternative alarm algorithm is used to reduce nuisance alarms¹¹⁰ during working hours).

The actual alarm algorithm can be read in menu H4/U5.

The alarm algorithm parameters can, for the whole system, be set in Win512, see chapter "Alarm algorithms", page 142. See also Win512 help.

16.4.2 Filtering algorithm

In order to secure a fast detection of real fire alarms and to reduce nuisance alarms to a minimum, the filtering algorithm is used.

The filtering algorithm uses the sensor value to calculate a decision value depending on which alarm algorithm that is selected. The decision value is zero from start. Each time a new sensor value is picked up (sampled) from an analog smoke detector 33xx / 430x, this new sensor value is compared with the actual decision value and the decision value will be adjusted as follows:

If the difference, between a new sensor value and the actual decision value is \leq "X", the decision value is set equal to the new sensor value. If the difference is $>$ "X", the decision value is increased or reduced by "X".

"X" = The Step Value is different depending on the sensitivity and detection time, i.e. the alarm algorithm, see Figure 16.

The decision value will consequently not be increased / decreased with a value exceeding the "X" value even if a sensor value is much higher / lower.

Analog detector	Normal detection time (15sec.)			Slow detection time (35sec.)		
	H-15 (2.4%, High sensitivity)	N-15 (3.0%, Normal sensitivity)	L-15 (3.6%, Low sensitivity)	H-35 (2.4%, High sensitivity)	N-35 (3.0%, Normal sensitivity)	L-35 (3.6%, Low sensitivity)
3304/4301	X=4	X=5	X=6	X=2	X=2	X=2
3316/4300	X=8	X=10	X=12	X=4	X=4	X=4

Figure 16. The six alarm algorithms. Default is alarm algorithm N-15, i.e. normal detection time (15 sec.) and normal sensitivity. X=The step value. (The L-15, H-35, N-35 and L-35 algorithms might not fulfil the EN54-7 specifications.)

Sensor/Decision values

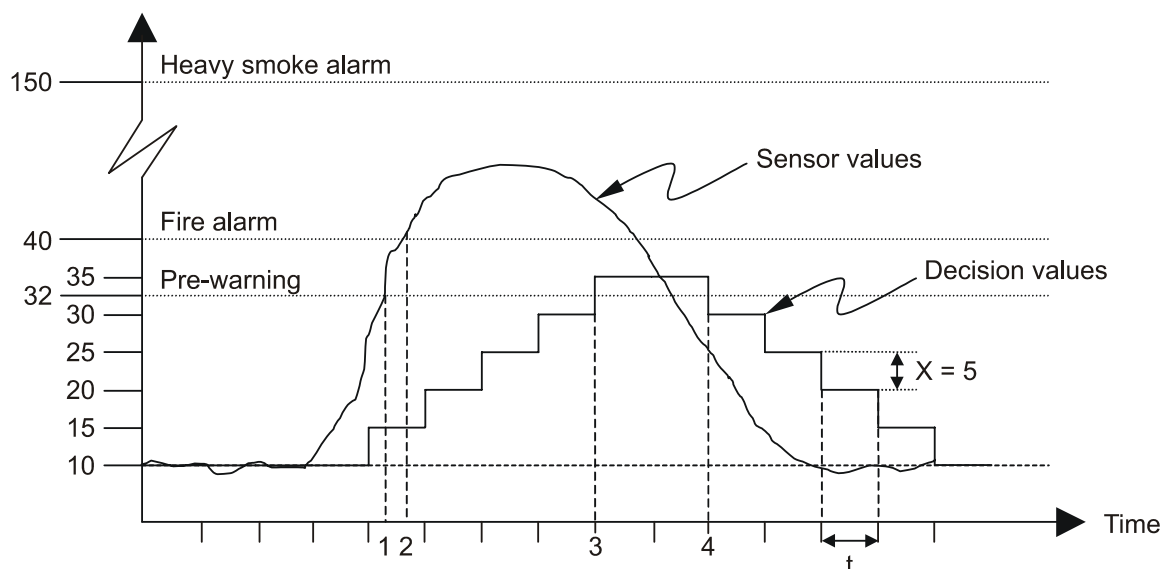

Figure 17. An example of the filtering algorithm with the alarm algorithm "N-15" selected, i.e. the step value $X = 5$.

Explanations to the figure:

Analog smoke detector 3304 / 4301. Normal detection time (15sec.) and normal sensitivity (i.e. alarm algorithm "N-15") results in $X = 5$. The detector polling time $t \approx 2.56$ sec. At the "starting point" the week average sensor value is "10", i.e. the pre-warning level has, due to contamination, been adjusted to "32" ($10+22$) and the fire alarm level to "40" ($10+30$).

The sensor values and decision values are approx. equal ("10"), until the polling when the sensor value becomes approx. "27". Since $27-10 > X=5$, the decision value ("10") is increased by $X=5$ to "15". Next polling the sensor value is approx. "45", i.e. the decision value ("15") is increased by $X=5$ to "20", and so on.

When the sensor value is reduced to approx. "25" the decision value is set to "30", because $35-25=10 > X=5$, i.e. the decision value ("35") is reduced by $X=5$ to "30", and so on.

1. The sensor value has here reached the pre-warning level but nothing will happen since the decision value has not reached the pre-warning level.
2. The sensor value has here reached the fire alarm level but nothing will happen since the decision value has not reached the fire alarm level.

3. The decision value has here reached the pre-warning level and pre-warning is activated.
4. The decision value is here below the pre-warning level and the pre-warning is automatically reset.

16.4.3 Smouldering smoke algorithm

The smoke from a smouldering fire brings the sensor value to rise very slowly. A smouldering fire can last for hours and sometimes days. The smouldering smoke algorithm will detect such a fire at an "early" stage.

The smouldering smoke algorithm is depending on and works in parallel with the selected alarm algorithm, i.e. the smouldering smoke algorithm can affect the pre-warning and fire alarm levels, see below.

If the decision value has been over the smouldering level for **7 minutes** (1-2 in the figure), the pre-warning and fire alarm levels are lowered:

- The pre-warning level is lowered to a level right between the original pre-warning level and the smouldering level.
- The fire alarm level is lowered to a level right between the original fire alarm level and the pre-warning level.

If the decision value has reached the pre-warning level, but not the fire alarm level, after **additional 90 minutes** (2-4 in the figure), the pre-warning and fire alarm levels are lowered again:

- The pre-warning level is lowered to the original smouldering level.
- The fire alarm level is lowered to the original pre-warning level.

The smouldering smoke algorithm is aborted and the pre-warning and fire alarm levels are restored to their original values if:

- The decision value becomes lower than the smouldering level.
- The decision value, after the **90 minutes**, has not reached the pre-warning level.
- The decision value, after the **90 minutes** and **additional 120 minutes**, has not reached the fire alarm level.

The smouldering offset can, for the whole system, be set in Win512, see chapter "Alarm algorithms", page 142.

Sensor/Decision values

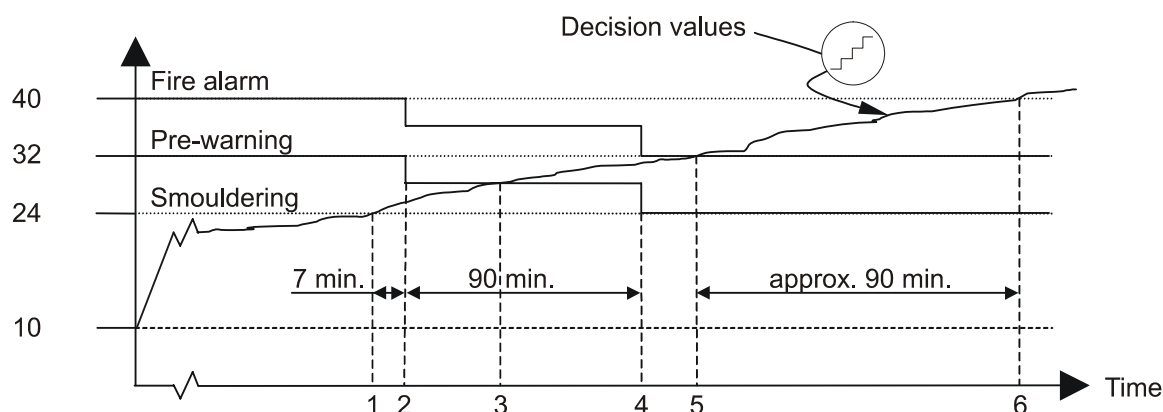

Figure 18. An example of the smouldering smoke algorithm.

Explanations to the figure:

Analog smoke detector 3304 / 4301. The week average sensor value is "10", i.e. the smouldering level has, due to contamination, been adjusted to "24", the pre-warning level to "32" and the fire alarm level to "40".

When a smouldering fire starts, the sensor values and the decision values will increase slowly upwards from "10".

1. The decision value has here reached the smouldering level. A 7 minutes timer is started.
2. After the 7 minutes the decision value is still over the smouldering level. The pre-warning level and the fire alarm level are lowered. A 90 minutes timer is started.
3. The decision value has here reached the pre-warning level and pre-warning is activated.
4. After the 90 minutes the decision value is still over the pre-warning level but has not reached the fire alarm level. The pre-warning level and the fire alarm level are lowered again. A 120 minutes timer is started.
5. The decision value has here reached the fire alarm level and fire alarm is activated.
6. The decision value has here reached the original fire alarm level, i.e. the fire alarm would have been activated approx. 90 minutes later than with the smouldering algorithm!

16.5 Performance factor

To find out how the environment is where an analog smoke detector 33xx / 430x is mounted, the **performance factor** can be studied.

The performance factor is calculated for each detector individually.

Each sensor value is compared with the week average sensor value. The absolute difference is saved and each twenty-four hour (at midnight) is an "average value" calculated, i.e. the performance factor.

If the detector is mounted in a very "stable" environment, the performance factor will be low (min. 0 %/m).

If the detector is mounted in a very "unstable" environment, the performance factor will be high (max. 2.55 %/m).

An "unstable" environment can cause nuisance alarms (unnecessary alarms). Perhaps should another type of detector be used, another alarm algorithm be used or other actions be taken, e.g. alert annunciation or two-address dependence.

The performance factor is shown in menu H4/U5 together with the min. and max. sensor values. All three values should be studied together. (E.g. one or two high sensor values will not result in a high performance factor.)

16.6

Algorithms for analog heat detectors

The following is valid <u>only</u> for the <u>analog</u> heat detector types 33xx / 430x in NORMAL mode (= AHD3308 / AMD3316 in Win512).

The detectors conforms to a class (see EN54-5:2000, clause 4.2) according to the requirements of the tests specified in EN54-5:2000, clause 5.

Each analog heat detector can have two alarm algorithms programmed (via Win512). One **alarm algorithm** that is normally used and one **alternative alarm algorithm** that is used when a time channel (internal or external) is activated. E.g. class A1 can be used in the night-time and class B can be used in the daytime (the alternative alarm algorithm is used to reduce nuisance alarms during working hours). The actual algorithm can be read in menu H4/U5.

When the c.i.e. has picked up a sensor value above the **fire alarm** level for a detector, the next two values from that detector also have to be above the fire alarm level to activate fire alarm in the c.i.e. (This results in an approx. 5 seconds alarm delay).

The same is valid for **pre-warning** only that it is a lower level than for fire alarm. (If pre-warning shall be presented or not, is selected in the "Control Unit" dialog box in Win512).

The same is valid for **heavy heat alarm** only that it is a higher level than for fire alarm. Heavy heat alarm will always be printed out and saved in the event log. (No other heavy heat alarm presentation).

The fire alarm, pre-warning and heavy heat alarm level respectively can, for the whole system, be set in Win512, see chapter "Alarm algorithms", page 142.

See EBL512 Operating instructions for more information.

16.6.1 **Class A1 algorithm**

Conforms to Class **A1**.

Typical / max. application temperature 25 / 50° C.

Max. / min. static response temperature 54 / 65° C.

The algorithm is as follows:

For a rate-of-rise $\leq 4^\circ$ C per minute:

Fire alarm level is 56° C.

Pre-warning level is 46° C.

Heavy heat alarm level is 90° C.

Rate-of-rise $> 4^\circ$ C per minute:

Fire alarm level is 46° C.

Pre-warning level is 36° C.

Heavy heat alarm level is 90° C.

The "Class A1 algorithm" will detect a fast temperature rise (rate-of-rise $> 4^\circ$ C per minute) some minutes earlier than the "Class A2 algorithm".

16.6.2 **Class A2 S algorithm**

Conforms to Class **A2 S**.

Typical / max. application temperature 25 / 50° C.

Max. / min. static response temperature 54 / 70° C.

The algorithm is as follows:

Fire alarm level is 60° C.

Pre-warning level is 50° C.

Heavy heat alarm level is 90° C.

16.6.3 **Class B S algorithm**

Conforms to Class **B S**.

Typical / max. application temperature 40 / 50° C.

Max. / min. static response temperature 69 / 85° C.

The algorithm is as follows:

Fire alarm level is 74° C.

Pre-warning level is 64° C.

Heavy heat alarm level is 90° C.

The "Class B S algorithm" can be used when the application temperature is "high" (compare with the "Class A1 an A2 S algorithms).

16.7 **Algorithm setting via menu H4/U5**

NOTE! Algorithm setting via menu H4/U5 is only valid for the "British Standard Marine Application" convention.

The alarm algorithm can be set via menu H4/U5 for the following detectors:

3304 in NORMAL mode

3308 / 3309 in NORMAL mode

3316 in NORMAL mode (the "Decision algorithm" is not possible to use)

430x in NORMAL mode

No alternative algorithm can be used.

No values (offset, level, etc.) can be set via menu H4/U5 (i.e. these values have to be set via Win512).

The "Short name" (set in Win512) can be ≤ 5 characters.

If an algorithm is set via menu H4/U5, the site specific data (SSD) in the c.i.e. is not equal to the SSD file downloaded from Win512, i.e. a back up is required to update the SSD file (xxxxxx.512).

If an algorithm is set via menu H4/U5, the information in menu H5/A4 will be changed from "Downloaded: xxxx" to "Modified by CU: xxxx".

See also the EBL512 Operating Instructions for version 2.1.x.

16.8

Self verification

The analog detectors 33xx / 430x (in NORMAL mode) have a built-in self verification function. The detector's HW is always supervised by the detector's S/W and CPU. Every minute, each detector will receive a question from the c.i.e. If the self verification function has detected any fault it will be reported back to the c.i.e. A fault will be activated in the system and the following fault message will be shown:

FAULT: Sensor techn. no. nnnnnn

16.9

Minimum / Maximum sensor values

To find out how the environment is, where an analog detector 33xx / 430x (in NORMAL mode) is mounted, the **minimum and maximum sensor values** can be studied. The sensor values are continuously picked up and evaluated by the control unit (c.i.e.) for each detector individually. Every value is checked if it is a new minimum or maximum value for that detector. At midnight every day a memory will be updated and the new minimum and maximum sensor values can be read in menu H4/U5¹¹¹.

For analog smoke detectors the minimum and maximum sensor values are shown as XX.X % (obscuration) per meter. (The values are not shown for analog smoke detectors type 23xx).

For analog heat detectors the values are shown as XX°C.

¹¹¹ I.e. the min. / max. sensor values shown, are from the previous day.

16.10 2-zone / 2-address dependence (co-incident alarm)

In some premises 2-zone / 2-address dependent fire alarm ("Two unit dependent" in Win512) can be used to avoid unwanted / false alarms (nuisance alarms). A time channel can be used to turn on/off this function.

16.10.1 2-zone dependence

Each zone in the system can be programmed to be "Two zone dependent" for fire alarm activation. The zone has to belong to one of nine "Two zone dependent groups" (1-9).¹¹²

Function: Two or more zones in the same group have to be in "fire alarm state"¹¹³ at the same time to activate fire alarm in the control unit. When only one of the zones is in "fire alarm state" it is indicated in the control unit (c.i.e.) as follows:

- the buzzer sounds like for pre-warning (0.8 / 5 sec.).
- In the alphanumeric display is the following text shown:
Co-incident alarm zone ZZZ
- The zone no. is also shown in menu H4/U4.

Programmable outputs can be activated by trigger condition "Two Zone Dependent Fire Alarm" but no other outputs will be activated.

16.10.2 2-address (-unit) dependence

Each analog detector, addressable multi purpose I/O unit (3361) monitored Input 0 (Z) and 8 zones expansion board (1580) input can be programmed for 2-unit dependent fire alarm activation. (Heat detectors should not and manual call points must not be 2-unit dependent).

Function: Two or more units in the same zone have to be in "fire alarm state"¹¹³ at the same time to activate a fire alarm in the control unit. When only one unit is in "fire alarm state" it is indicated in the control unit (c.i.e.) as follows:

- the buzzer sounds like for pre-warning (0.8 / 5 sec.).
- In the alphanumeric display is the following text shown:
Co-incident alarm detector ZZZ/AA
- The zone no. and address is also shown in menu H4/U4.

Programmable outputs can be activated by trigger condition "Two Detector Dependent Fire Alarm" but no other outputs will be activated.

¹¹² Default for all zones is group no. 0 = **no** Two zone dependence. See also chapter "Two zone dependence", page 145.

¹¹³ Fire alarm state is when a fire alarm normally would have been activated in the c.i.e.

16.10.3 Reset of 2-zone / 2-address dependence (co-incident alarm)

The unit / zone having activated a co-incident alarm will be latched in this status for 5 minutes and then automatically reset. During these 5 minutes the push button "Reset", on the c.i.e. front / FBP, can be used to manually reset the co-incident alarm.

If, during these 5 minutes, at least one more unit / zone comes into "fire alarm state", the co-incident alarm ends and normal fire alarm will be activated in the c.i.e.

16.11 Delayed alarm

In some premises delayed fire alarm activation can be used to avoid unwanted false alarms (nuisance alarms). The delay time will be added at the end when a fire alarm normally would have been activated in the c.i.e. This function is a violation to the EN54-2 standard.

Each analog or addressable detector, each addressable multi purpose I/O unit (3361) monitored input (Z) and 8 zones expansion board (1580) input in the system can be programmed (in Win512) to delayed fire alarm activation. (Heat detectors should not and manual call points must not have delayed fire alarm activation). The delay time can be set to 1-127 seconds.¹¹⁴

Function for an analog or addressable smoke detector: An alarm point in "fire alarm state"¹¹³ has to be in this state all the delay time, in order to activate fire alarm in the control unit. If an alarm point goes back to "normal state" during the delay time, the delay time will be reset and start again if/when the alarm point comes in "fire alarm state" again.

Function for each addressable multi purpose I/O unit (3361) monitored Input 0 (Z) and 8 zones expansion board (1580) input: A zone in "fire alarm state" will be recorded in the control unit but fire alarm will not be activated. When the delay time is out the zone will be reset and if it still is in "fire alarm state", fire alarm will be activated in the control unit.

16.12 Alert annunciation

In some installations the Alert Annunciation function can be used to avoid unwanted false alarms (nuisance alarms) to the fire brigade. A time channel can be used to turn on/off this function.

Trained personnel on site are required to locate the fire (the room) and take the correct measures depending on if there is a fire or not.

Normally analog smoke detectors and zones with smoke detectors only, come in question to be programmed (in Win512) for alert annunciation. Heat detectors and manual call points should normally

¹¹⁴ Default is 0 seconds and a normal delay time is ≤ 30 seconds.

not come in question for alert annunciation. A manual call point can only activate the **AA** function if there are no other fire alarms activated in the system (i.e. the second fire alarm will turn OFF the **AA** function). This is also valid if "Multiple alarms within same zone" is selected.

The **AA** function is normally ON (enabled) during the daytime working hours only. A time channel can be used to turn ON / OFF (enable / disable) the **AA** function.¹¹⁵

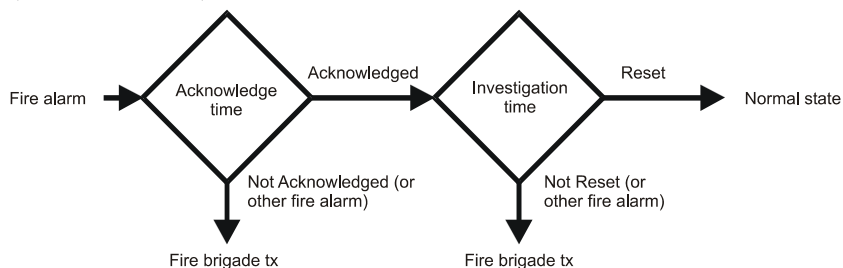

Figure 19. The Alert Annunciation function.

Function: Indications, print-outs, actions, etc. for an **AA** alarm are the same as for a normal fire alarm **except the output for routing equipment (fire brigade tx), in each c.i.e. that will not be activated directly.**¹¹⁶

The fire alarm has to be acknowledged within an acknowledge time and the fire alarm has to be reset within an investigation time, else the output(s) for routing equipment (fire brigade tx) will be activated.

During the acknowledge and investigation times:

- If a fire alarm is activated by a detector / zone not programmed for Alert Annunciation or if fire alarm is activated by a manual call point, the output(s) for routing equipment (fire brigade tx) will be activated.
- If a fire alarm is activated by a detector / zone which is programmed for Alert Annunciation, it is depending on if "Multiple alarms allowed within same zone" is selected in Win512 or not¹¹⁷. The number of zones¹¹⁸ allowed activating AA

¹¹⁵ The alert annunciation function ON (enabled) is indicated by the LED "Fire brigade tx delay". Normally is only one time channel used for this function but two or more channels can be used. The **AA** function can, as an alternative, be continuously "on". **NOTE!** The **AA** function can be deactivated (disabled) via menu H8/S6 and will stay so until re-activated (re-enabled) again via menu H8/S6.

¹¹⁶ **NOTE!** Programmable outputs type = Routing Equipment, will however be activated if not the following is added to the control expression: **&&!Alert Annunciation Activated.**

¹¹⁷ Default the Check box in "System properties" is not marked = Multiple alarms are not allowed within same zone.

¹¹⁸ Default is one zone. Up to four zones can be set.

alarms, before the output(s) for routing equipment (fire brigade tx) will be activated, is also set in Win512 "System properties".

Acknowledge and Reset is done on the Alert annunciation unit 1735 / 1736 or Alert annunciation controller 1740. A programmable output ("Alert Announcement Activated") for indication and a programmable input ("Alert Announcement Acknowledge" / "Alert Announcement Reset") can also be used.

The Acknowledge time can be set to 5-300 seconds.

The Investigation time can be set to 1-40 minutes.

NOTE! According to EN54-2, the total delay of fire alarm routing equipment must not exceed 10 minutes (i.e. Acknowledge time + Investigation time ≤ 10 min.).

16.13 Alarm Acknowledgement Facility (AAF)

This function is similar to the "Alert Annunciation Function" (described above).

One AAF zone can be one to five analog smoke detectors (4300 / 4301), one AAF buzzer (e.g. Sounder base 3378) and one AAF Control (AAFC)¹¹⁹. All connected on a COM loop.

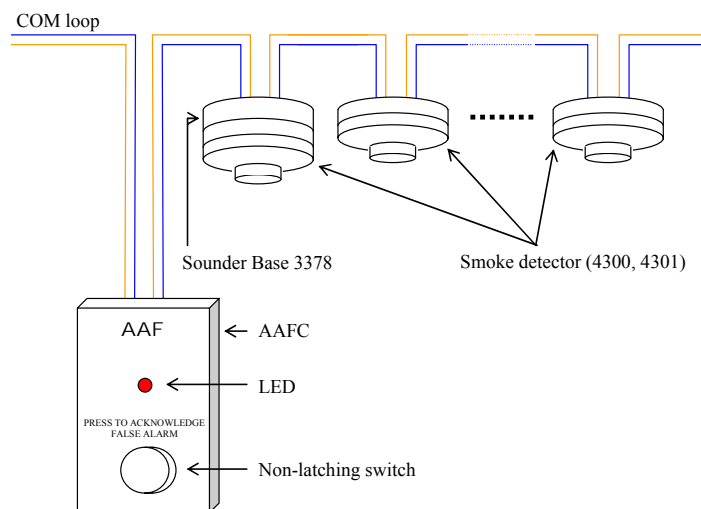

Figure 20. Alarm Acknowledgement Facility units.

Function (see also the flow chart in the following figure):

- One of the detectors in an AAF zone reaches its fire alarm level. The AA Process starts and the AAF buzzer sounds.
- An **Acknowledgement Period** starts (AP=10-60 sec. -- programmable).
- If it is a false alarm, acknowledged the alarm on the AAFC before the AP is ended.
- After acknowledgement an **Investigation Period** starts and the AAF buzzer is silent

¹¹⁹ This unit is available on the Australian market only.

(IP=0-3 min. -- programmable).

If all the detectors in the AAF zone becomes normal again (goes below the fire alarm level respectively) during the IP, the AAP ends.

If the AP or the IP runs out during the AAP and any detector in the AAF zone still is over its fire alarm level, normal fire alarm(s) will be activated.

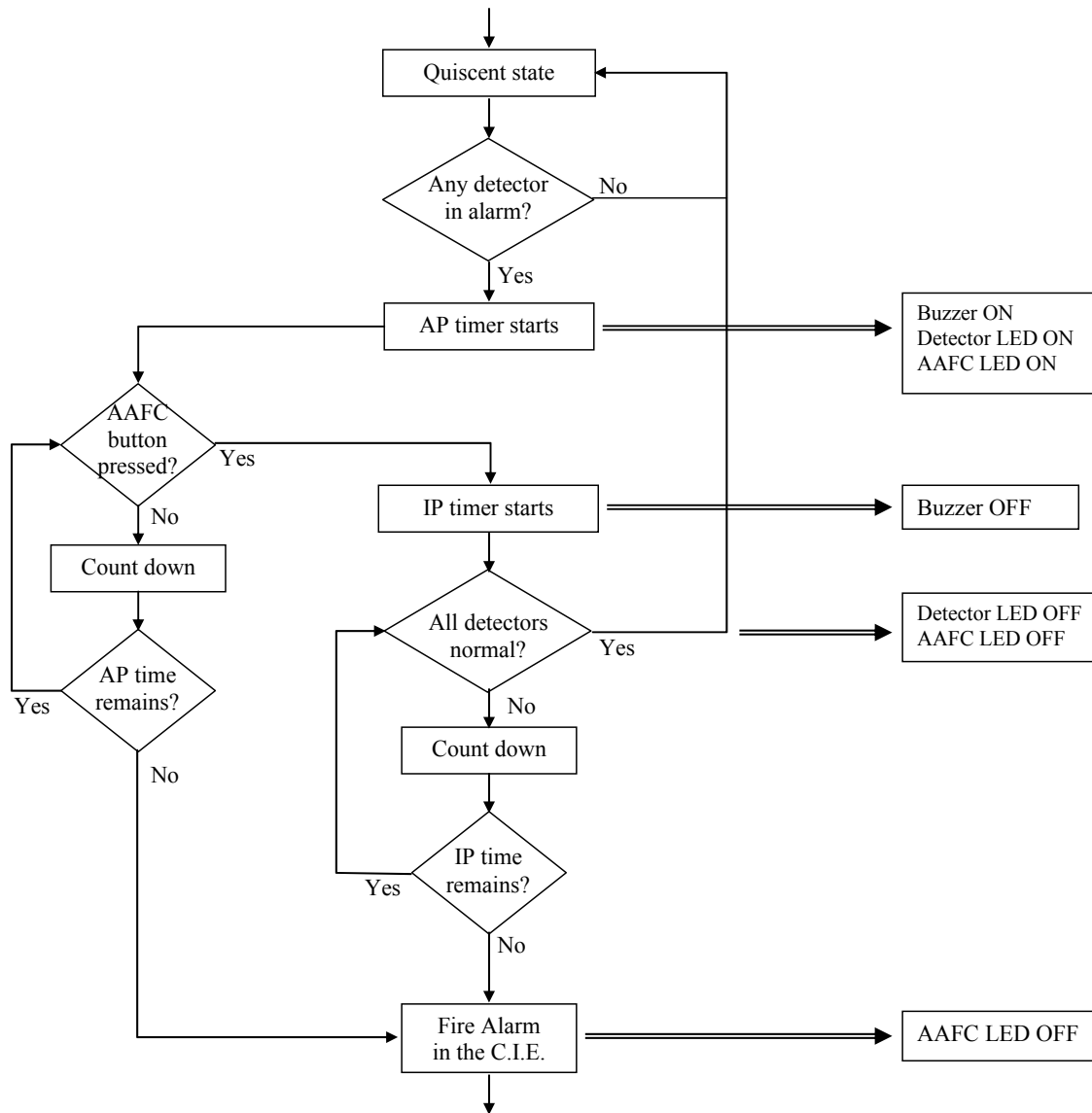

Figure 21. Alarm Acknowledgement Facility (AAF) flow chart.

During the AAF process, an AAF alarm will be indicated in the c.i.e. display

.... during the acknowledgement period (AP):

AAF zone xx, activated

.... during the investigation period (IP):

AAF zone xx, investigation in progress

The AAF zone xx (xx=00-99) is only valid for the c.i.e. it is shown in, i.e. not the system.

If more than one AAF zones have been activated only the first is shown in the display.

NOTE!

All devices within the same AAF zone must be connected to the same c.i.e.

The detectors in an AAF zone can be one to five and not be programmed as 2-unit-dependent and not be controlled by the Alert Annunciation function.

Only Analog photo electric smoke detector 4301 and Analog multi detector 4300 can be used for AAF. If the Analog multi detector 4300 is used, it must be programmed as type "Two addresses", so that only the "smoke part" of the detector can be used for AAF.

Max. 100 AAF zones per c.i.e.

The AAF buzzer (e.g. Sounder base 3378) has to be programmed with the trigger condition no. 41 = AAF zone alarm (and/or other trigger conditions).

16.14

Quiet alarm

Quiet alarm is e.g. used in conjunction with the I/O Matrix board 4582¹²⁰, an application board for fan control and an I/O unit 3361 for fan control.

NOTE! These units are available on the Australian market only.

Smoke detectors, programmed for quiet alarm, can be used e.g. for controlling fans (stop / start depending on the type of fan).

Indications and actions:

- In the c.i.e. display: Quiet alarm detector ZZZ/AA and a user definable text message (alarm text) if programmed.
- LED:s "Fire" in the c.i.e. are blinking (0.4 / 0.4 sec.).
- Buzzer in the c.i.e. sounding (0.8 / 5 sec.).
- Programmable outputs for quiet alarm, e.g. 3361 outputs controlling supply air fans and standard fans i.e. any output with a control expression containing trigger conditions no. 42 = Quiet Alarm Zone or no. 43 = Quiet Alarm Zone Address.

Quiet alarms are non-latching, i.e. they will be automatically reset when the alarm point / zone is no longer above alarm level.

¹²⁰ See "I/O Matrix board 4582", page 55.

NOTE! Quiet alarm can also be programmed (trigger cond. 99) for a 3361 unit "zone line input". In such a case only non-latching detectors can be used.

16.15 Disable alarm points and outputs

Temporary disablements are made via the menu H2 sub menus B1-B3. For more information see EBL512 Operating Instructions, chapter "Disable or re-enable (H2)". Disablements are re-enabled via the menu H2 sub menus B4-B6.

Regular disablements are made via time channels, see chapter "Time channels", page 139.

When "Single encapsulated reset" is selected in the Win512 "System properties" the function is as follows:

If an alarm point or zone is *in alarm state when being reset* it will not only be reset but also disabled. It has to be re-enabled (via menu H2/B5) the same way as if it was disabled via menu H2/B1-B2.¹²¹

Disabled alarm points and outputs are indicated by LED "Disablements" and are listed in menu H4/U1.

Enhanced Disablement (Default) = Fire alarm, pre-warning and fault signal can not be activated by the disabled alarm point/zone. If only fire alarm and pre-warning shall be disabled, Enhanced Disablement shall be re-enabled, see chapter "Miscellaneous", page 138.

NOTE! Enhanced Disablement is NOT valid when a time channel is used for disablements, only when menu H2/B1 or B2 is used.

16.15.1 Disable zone

A whole zone (all addresses within a zone, except the manual call points) can be disabled via menu H2/B1. Re-enable via menu H2/B4.

16.15.2 Disable zone / address

Individual alarm points can be disabled via menu H2/B2. Re-enable via menu H2/B5.

Time channels can be used to disable and re-enable automatically.

16.15.3 Disable control output

Individual control outputs can be disabled via menu H2/B3. Re-enable via menu H2/B6. Disabled output will stay in (or return to) the normal condition for the output respectively.

16.15.4 Disable / Re-enable all control, exting. and ventilation outputs

The control outputs of type "Control (general)", "Fire ventilation" and "Extinguishing system" can be collectively disabled via menu H2/B8. It

¹²¹ This function was earlier called "Encapsulation" (encapsulated reset). Menu H2/B7 had to be used to re-enable an encapsulated non-reset alarm point. **Menu H2/B7 has no function in this S/W version.**

is possible to do this for one or more specific control units or for all control units (i.e. the whole system). Re-enable via menu H2/B8. Disabled outputs will stay in (or return to) the normal condition for the output respectively.

16.15.5 Disable / Re-enable alarm devices

The control outputs of type "Alarm device (sounder)" can be collective disabled via menu H2/B9. It is possible to do this for one or more specific control units or for all control units (i.e. the whole system). Re-enable via menu H2/B9. Disabled outputs will stay in (or return to) the normal condition for the output respectively.

16.16 Disable interlocking output

Disable via menu H9/C4. Re-enable via menu H9/C5. See also chapter "Disable interlocking output (H9/C4)", page 91.

16.17 Disable outputs for routing equipment

Disable and Re-enable via menu H8/S1. For more information see EBL512 Operating Instructions.

16.18 Disconnect / Re-connect loop

Disconnect via menu H8/S2 and Re-connect via menu H8/S3:

0. COM loops
1. BS4 loops
2. 8 zones expansion board 1580 (zone line input)
3. Addressable zone interface 2226 / 2335 / 3361 (zone line input)

For more information see EBL512 Operating Instructions.

16.19 External time channels 15-63

External time channels can be used to:

- disable and re-enable alarm points
- set the Alert Annunciation function ON / OFF
- activate programmable control outputs
- set alternative alarm algorithm for analog detector types 33xx / 430x ON / OFF
- set the 2-unit dependence function ON / OFF

External time channels 15-63 are for the whole system. A programmable input ("Time Channel NN") is used for each time channel. The input is controlled by some external equipment, e.g. another time system, a key switch, a timer, etc. with a normally open contact (normally low) or a normally closed contact (normally high). When the input is "activated" the time channel is ON.

NOTE! Do not use more than one input per time channel. (This is checked in the "Validity check" in Win512).

16.20 Test mode

Up to four zones can be set in Test mode at the same time.¹²² Alarm points / zones can be tested during the Monthly test (via menu H1) or separately (via menu H7). For more information see EBL512 Operating Instructions. The LED "Test mode" indicates one or more zones in Test mode. Zones in Test mode are also simultaneously shown in the c.i.e. alphanumeric display. Disablements, faults and fire alarms have higher priority, i.e. the presentation of zones in Test mode will be suppressed during such a condition. In order to shorten the testing time, any time delay for a zone / detector in test mode will be "disabled".¹²³

16.21 Test alarm devices

The programmable outputs type "Alarm device" can be collectively activated via menu H8/S7, which make it possible to test the alarm devices. (The test can not be started if fire alarm is activated in the system.). One or all control units can be selected. When the test starts the alarm devices will be "on" for 5 seconds ($\pm 1s$), "off" for 25 seconds ($\pm 1s$), "on" for 5 seconds and so on.¹²⁴ **NOTE!** Also disabled (and silenced) alarm devices will be tested.

The test will continue for one hour, is stopped via menu H8/S7 or if a fire alarm is activated in the system.

16.22 Test of routing equipment

Via menu H1 it is possible to test the fault and fire alarm outputs for routing equipment (Fault tx, Fire brigade tx and corresponding programmable outputs). Open door etc. will not affect the test.

In menu H1, press "Accept" to start the test. The fault output will be activated¹²⁵, indicated by LED "Fault tx activated". After 30 seconds will also the fire output(s) be activated, indicated by LED "Fire brigade tx". After additional 30 seconds the test will be ended and the outputs and LEDs will go back to "normal" status.

16.23 Calibration of supervised outputs

The supervised (monitored) outputs have to be calibrated after the installation. This is done via a menu (H5/A1) in the c.i.e.

¹²² In DBI (Danish) convention only one zone.

¹²³ The test mode alarm will be activated at the pre-warning level. Any 2-zone / -address dependence and the function "delayed alarm" will be ignored.

¹²⁴ The output activation will be continuously (steady). For the alarm devices 3377 and 3378, the tone with the highest priority level (and type "alarm device") will be automatically selected.

¹²⁵ **NOTE!** Fault outputs are normally activated in "normal" state, i.e. they will in this case be de-activated.

S/W version \leq 2.2.2: If the actual value differs from the calibrated value \pm a small tolerance, a fault will be generated.

S/W version \geq 2.2.3: Calibration range is 4K7 – 50K.¹²⁶ If the calibrated value is outside that range or if the actual value differs from the calibrated value \pm a small tolerance, a fault will be generated.

16.24 Service signal

All smoke detectors get contaminated no matter what environment it is mounted in. In some environments it goes faster than in others.

Conventional smoke detector:¹²⁷ The sensitivity will increase in some environments and decrease in others. This can result in unwanted false alarms (nuisance alarms) or no alarms at all.

Analog smoke detector:¹²⁸ The detector is supervised at all times and when required, a service signal will be activated.

Service signal levels (low / high level) for the different types:

4300, 4301 ¹²⁹	- / 1.8	(obscuration in %/m)
3304, 3316:	- / 1.8	(obscuration in %/m)
2300, 2304:	5 / 30	(on a scale 0-63)
2200, 2202:	10 / 60	(on a scale 0-127)
Autronica:	5 / 100	(on a scale 0-240)
4300, 4301 ¹³⁰ :	After a compensation of 2 %/m.	

For more information, see EBL512 Operating Instructions chapter "Sensors activating Service signal (H4/U6)" and "Acknowledge Service signal (H8/S4)".

16.25 Analog smoke detector

An analog smoke detector is like a "sensor". It senses its environment at all times. Analog values are converted to digital values, "**sensor values**", which are continuously picked up and evaluated by the control unit (c.i.e.) for each detector individually. In Figure 22 the (analog) sensor values are represented by the graph "Working level".

Analog smoke detectors 23xx (and 33xx / 430x in 2312 mode¹³¹):

Each hour, one sensor value is stored (in the c.i.e.) and each week a

¹²⁶ Only valid for the c.i.e. outputs S0-S3. Up to five 33K resistors can be used.

¹²⁷ Conventional smoke detectors (except 4350) have a fixed fire alarm level.

¹²⁸ An analog smoke detector adapts its fire alarm level in relation to how contaminated it is, see chapt. "Analog smoke detector", page 111.

¹²⁹ In the NORMAL mode.

¹³⁰ In the 2330 mode (but no service signal output).

¹³¹ Regarding analog smoke detectors 33xx in NORMAL mode, see chapter "Alarm algorithms for smoke detectors / Detection levels / Offsets", page 93.

new "**week average sensor value**" is calculated¹³². In Figure 22 the week average sensor values are represented by the graph "Week average". **NOTE!** The graph can be adjusted up or downwards!

Each type of analog smoke detector has a specific default sensor value ("Working level" & "Week average" at "Time 0"). A **fire alarm offset** (value) is added to get the detector's **fire alarm level**. The fire alarm level will be adjusted in relation to each new week average sensor value, i.e. the detector's fire alarm sensitivity is constant during one week and then adjusted if required. The fire alarm level is in Figure 22 represented by the graph "Fire alarm level".

Service signal will be given for a high and a low level, see "Service level" in Figure 22. See also chapter "Service signal", page 111.

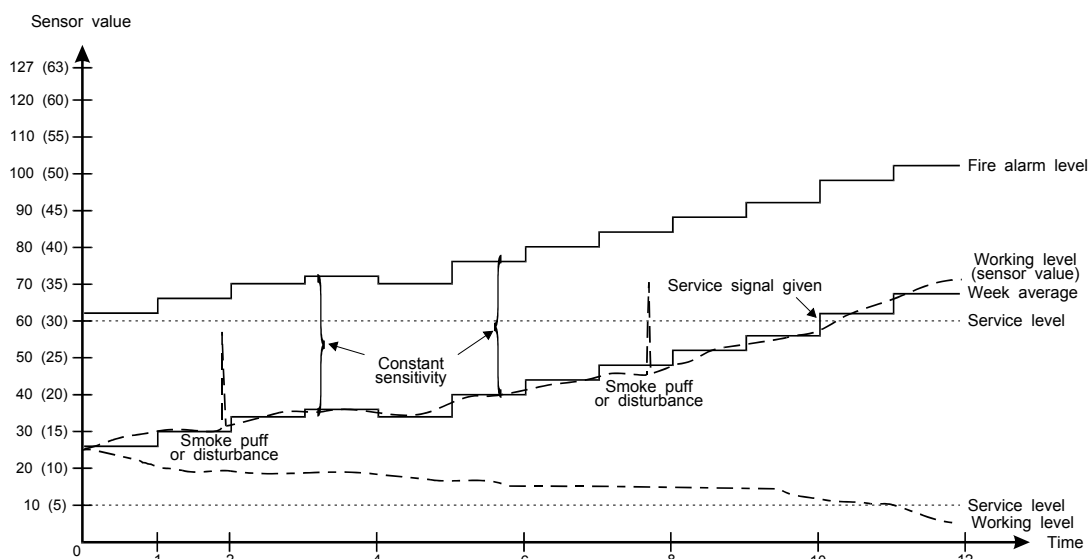

Figure 22. Working principle for the first generation of an analog smoke detector (sensor), type 23xx (also 33xx / 430x in 2312 mode). Sensor value, working level, week average sensor value, fire alarm offset / level and service level.

Via Win512 and a PC connected to a control unit, you can get "Sensor Information", for all analog detectors on a COM loop or an individual detector, as follows:

Technical no. | Zone-Address | Min. | Max. | Momentary | Weekly | Performance factor.

For smoke detectors the obscuration in % per meter and for heat detectors in °C. For some type of detectors, not all information can be shown. For an individual detector you can get the information continuously. See also Win512 help.

¹³² The values stored during the week are used to calculate a new week average sensor value. The very first week average sensor value will be calculated within 2 minutes after SSD download & restart. (During this "2 min. period" no fire alarm can be activated.)

16.26 Fault signal (fault condition)

Fault signal, fault messages, fault acknowledge, etc. are described in EBL512 Operating Instructions, chapter "Fault".

Programmable inputs can be used to activate fault signal in the EBL512 control unit, see chapter "Programmable inputs", page 68.

16.27 User definable text messages

When a fire alarm is activated, the presentation number will be shown on the first row in the control unit's alphanumeric display.¹³³ On the second row, a user definable text message (alarm text) will be shown, if programmed.¹³⁴ The user definable text message will also be printed out when a printer is available.

When only one fire alarm is activated in a zone, both the zone number and the address will be shown and an individual user definable text message (if programmed) will be shown for that alarm point.

When more fire alarms are activated in a zone, only the zone number will be shown and an individual user definable text message (if programmed) will be shown for the zone.

See also EBL512 Operating Instructions, chapter "Fire alarm".

The texts¹³⁵, up to 40 alphanumeric characters, are created and downloaded via Win512.

Each addressable alarm point can have one user definable text message displayed in the control units and in each Ext. FBP:s 1826 & 1828, in the Alert Annunciation units 1735 & 1736, in the Ext. Presentation unit 1728. See also Win512 help.

16.27.1 Creating the user definable text messages via Win512

For more information, see also Win512 help.

In the "Texts" menu select "Edit" and a "Win512 Texts" window will be displayed. This is a table ("Excel") with three columns, **Tech No**, **Zone-Addr** and **Text**.

Some examples are to be found in the following table. Explanations follow the table.

	Tech No	Zone-Addr	Text
1a		001-01	Fire in Laboratory 2 Floor
1b		002-00	Fire in Entrance

¹³³ Also in the Ext. FBP:s 1826 & 1828, in the Alert Annunciation units 1735 & 1736 and in the Ext. Presentation unit 1728.

¹³⁴ See also chapter "Limitations", page 165.

¹³⁵ Up to 194 texts if the 8K EEPROM is used and up to 816 texts if the 32K EEPROM is used in the display unit.

3	C00	default	FIRE ALARM
5	inter	001-01	Interlocking combination Area 001 - Point 01
6	D00102	001-01	Fire in Laboratory

Figure 23. Examples of user definable text messages.

Tech No column

1. The **Tech No** column shall not be filled in when creating a text for a specific addressable alarm point (1a) or a whole zone (1b), to be shown in the Control unit(s) / ext. FBP:s 2425/2426/2428.
3. The **Tech No** column shall be filled in with the Control unit's technical number (e.g. C00) when creating a "default" text (see below), to be shown in the Control unit.
5. The **Tech No** column shall be filled in with the word "inter" when creating a text for an Interlocking combination.
6. The **Tech No** column shall be filled in with the EPU 1728, AAU 1735 / 1736 or ext. FBP 1826 / 1828 technical number (e.g. D00102) when creating a text to be shown in the unit, instead of the text sent out from the c.i.e. to the unit.¹³⁶ D = "display unit", 00 = control unit, 1 = expansion board address (0 or 1) and 02 = the unit's address (00-15).

Zone-Addr column

- 1a. The **Zone-Addr** column shall be filled in with the presentation number (Zone-Addr) when creating a text for a specific addressable alarm point.
- 1b. The **Zone-Addr** column shall be filled in with the presentation number (Zone-Addr) when creating a text for a specific zone, i.e. the address "00" shall be written when only the zone number is to be shown.
4. The **Zone-Addr** column shall be filled in with the word "default" when creating a "default" text (see below), to be shown in this Display unit.
5. The **Zone-Addr** column shall be filled in with the presentation number (Area-Point) when creating a text for an Interlocking combination.
6. The **Zone-Addr** column shall be filled in when creating a text for a specific addressable alarm point, to be shown in a DU 1728 / 1735 / 1736 or ext. FBP 1826 / 1828, i.e. the presentation number (Zone-Addr) shall be written here.

¹³⁶ The unit has to be set in S/W mode xxxx – **1587**.

Text column

A tip: Click "Preview" and each text will be shown (in the different types of alphanumeric displays) at the same time as it is typed.

In a "default" text (see below), the first parameter symbol # will be replaced with the zone number (up to three digits) and the second parameter symbol # will be replaced with the address number (up to two digits) when presented in the alphanumeric display.

NOTE! When programming a specific addressable alarm point (e.g. an analog smoke detector), there is a "Text" field in the dialog box. The user definable text message can be written directly in this field. It will automatically be added, together with the presentation number, in the table / list described above.

In a large system, i.e. many texts, a "Filter" can be used to show only desired data. The columns, **Tech No**, **Zone-Addr** and **Text** can be used with "equal to" (==), "less than" (<), "more than" (>), "not equal to" (!=) and "a sub string" (€).

Three rows can be used with an "OR operator" (checkbox "And" not marked) or an "AND operator".

E.g. show only technical numbers less than 000100: **Technical number < 000100**. Mark the checkbox "Filter active" and click "OK".

Default text

1. Global function (default):

A "default" text can be created for each Control unit. All addressable alarm points that have no individual text, will be presented with the "default" text.

16.27.3

Downloading texts to the DU:s 1728 / 1735 / 1736 and ext. FBP:s 1826 / 1828

The unit respectively has to be set in S/W mode xxxx – **1587**.

The texts will be downloaded when the c.i.e. site specific data (SSD) is downloaded via Win512.

16.28

Real time clock (RTC)

Each control unit has an RTC. It is used for (date) and time presentation for fire alarms, faults, event logging and to control the time channels 1-14. In a system (i.e. two or more control units in a TLON network) are all control units synchronised.¹³⁹

¹³⁷ The unit has to be connected to the COM loop and programmed via Win512. A "PC communication interface" 4001 is plugged in the Display unit "K1" connector (6-way MODULAR) and in the PC COM port.

¹³⁸ To add a Display unit, select a COM loop icon, click on the right mouse button. In the Loop X pop-up menu, select "Add Loop Unit" and an "AD, Alphanumeric Display" (Display unit) dialog box will be displayed.

¹³⁹ The calendar and clock can be set in any c.i.e. for the whole system. Every day (at midnight) the calendar and clock will be synchronised.

16.29 Printer disable function

NOTE! Only valid for Chinese convention.

16.30 Loss of main power source

Fault signal delay time for "Loss of main power source" can be set (in Win512) to 1 – 300 minutes. Note, that a delay time > 30 minutes is a violation to the EN54-2 standard.

16.31 Win512 Tools menu

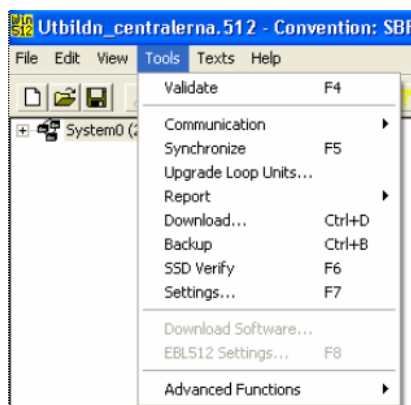

Figure 24 . Win512 "Tools" menu. Some commands can be disabled, see Win512 help.

The Win512 "Tools" menu is used, when the PC is connected to an EBL512 control unit for e.g. download / backup of SSD.

Validate: The SSD is validated before downloaded to an EBL512.

Communication: Log on / Log off to the EBL512.

Synchronize: (When connected and logged on to an EBL512.) Synchronization of control units (same data in all control units).

Upgrade Loop Units: To upgrade 33xx detectors to NORMAL mode (one at a time or all on one COM loop at the same time).

Report: Prints out a "Zone-Address → Output" list or a "Time channel → Zone-Address" list.

Download: (When connected and logged on to an EBL512.) For downloading of SSD to one or more EBL512 units.

Backup: (When connected and logged on to an EBL512.) For backup (upload) of SSD from all the EBL512 units.

SSD verify: (When connected and logged on to an EBL512.) The Win512 SSD is compared to the EBL512 SSD.

Settings: Some settings (e.g. for communication), convention, etc.

Download software: (When connected and not logged on to an EBL512.) For download of S/W (+ S/W text file) to the EBL512 unit.

EBL512 settings: (When connected and not logged on to an EBL512.) Read or download EBL512 settings to an EBL512 unit. The existing EBL512 SSD can be cleared (erased).

Advanced functions: No "Level" selected = Alarm algorithm parameters can not be changed. "Level 1" selected = Alarm algorithm parameters can be changed, but not for fire alarm. "Level 2" selected (a password is required) = Alarm algorithm parameters can be changed, also for fire alarm. Convention is possible to change (in "Settings").

17 Redundancy in distributed system

In a distributed system (i.e. two or more control units in a TLON network), with fire alarm routing equipment in only one of the control units, it is possible to indicate fire alarm and to activate the output for fire alarm routing equipment (fire brigade tx) even in case of a single open circuit (cut-off) or single short circuit in the TLON network.

NOTE!

This function is only valid for the non-programmable standard output for fire alarm routing equipment (fire brigade tx). The programmable outputs have no benefit of this function. The system planner (commissioner) should for any output, avoid such control expression (trigger conditions) that for the correct function is dependent on no fault on the TLON network.

There are two ways of system build-up:

- **Master and slaves** individually connected to the master.
- **Master and several control units** connected in parallel and connected to one input in the master.

17.1 Master and Slaves

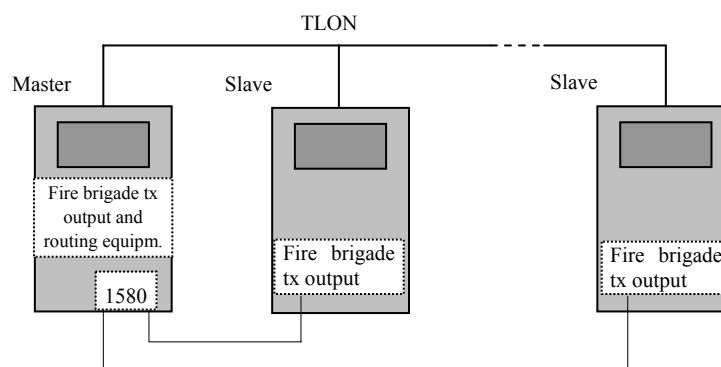

Figure 25. Master and slaves. Each slave is individually connected to the master via 1580 board(s) and/or 3361 unit(s).

17.1.1 Master unit

The control unit containing the fire alarm routing equipment is called the "**Master**". Each one of the other control units in the system is called a "**Slave**".

The master has to be equipped with one or more 8 zones expansion board 1580 and/or I/O unit 3361. Each slave has to be connected to a zone line input. (One slave per zone line input.)

Each zone line input used for this purpose (on the 1580 board and 3361 unit respectively), has to be programmed as "Alarm from CU" (i.e. type 3 and type 25 respectively).

17.1.2

Slave unit

Each "Slave", i.e. the non-programmable output for fire alarm routing equipment (fire brigade tx), has to be connected to an "Alarm from CU" input in the master. The output is connected like one alarm point with an end-of-line device:

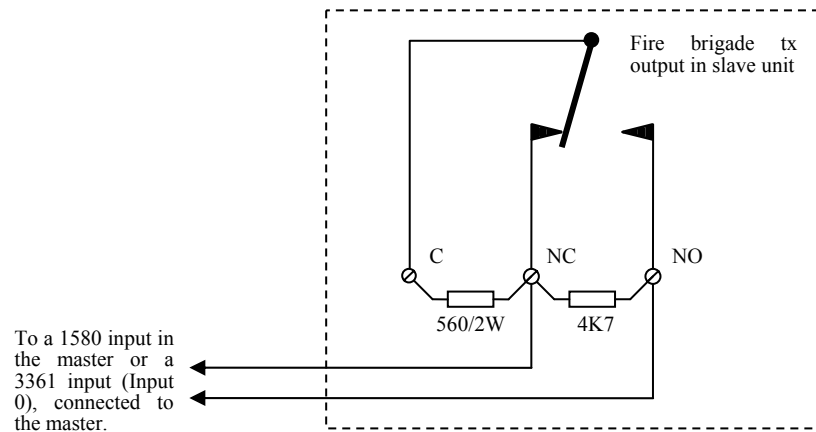

Figure 26. The output for fire alarm routing equipment (fire brigade tx) in each slave. Relay contacts shown in quiescent condition. One end-of-line device (a resistor 4K7 for a 1580 input and a capacitor 470 nF for a 3361 input) and one alarm resistor (560Ω / 2W) shall be connected according to the figure.

Slave

The output for fire alarm routing equipment (fire brigade tx) in a slave unit will be activated¹⁴⁰ as follows:

- **No fault** on the TLON network **AND** fire alarm in the system.

or

- **Fault** on the TLON network (a single open circuit (cut-off) or single short circuit) **AND** fire alarm activated by the slave itself.

Master

The output for fire alarm routing equipment (fire brigade tx) in the master will be activated¹⁴⁰ as follows:

- Fire alarm in the system.

or

¹⁴⁰ Also normal fire alarm indication, activation of outputs etc.

- **Fault** on the TLON network **AND** fire alarm activated by any slave, which will be specially presented, see below.

or

- **No fault** on the TLON network **AND** fire alarm activated by any slave **AND** no other fire alarm in the system. (In this case also a fault will be generated, see below.)

The slave inputs in the master will be "blocked" as follows:

- **No fault** on the TLON network **AND** Fire alarm in the system.

Presentation of slave unit fire alarm

In the master, a fire alarm activated by a slave will be presented as in the following example:

```
POINT: 999-02                               No. :001
User definable text message
```

The zone number "999" indicates that the fire alarm is activated by a slave. The address "02" indicates the slave, in this example control unit number 02. The user definable text message may be used to indicate that the alarm originates from a CU (slave).

Presentation of slave unit fault

An open circuit (cut-off) or short circuit on the slave inputs in the master will generate a fault and a fault message as follows (depending on which unit is used):

```
FAULT:Cut-off input n,1580 board b, CU xx
```

```
FAULT:Sh-circ input n,1580 board b, CU xx
```

n = zone line input (0-7) on the 1580 board.

b = 1580 board no. (0-5) in the master

xx = control unit no. (00-29) of the master.

or (for a 3361 unit, Input 0)

```
FAULT: Zone line input, tech no xxxxxx
```

xxxxxx = Technical number for the 3361 unit (Input 0)

No fault on the TLON network **AND** fire alarm activated by any slave **AND** no other fire alarm in the system will, besides the fire alarm, generate a fault and a fault message as follows (depending on which unit is used):

```
FAULT: Alarm input n,1580 board b, CU xx
```

n = zone line input (0-7) on the 1580 board.

b = 1580 board no. (0-5) in the master

xx = control unit no. (00-29) of the master.

or (for a 3361 unit, Input 0)

FAULT: Alarm input, tech no xxxxxx

xxxxxx = Technical number for the 3361 unit (Input 0)

17.2 Several control units

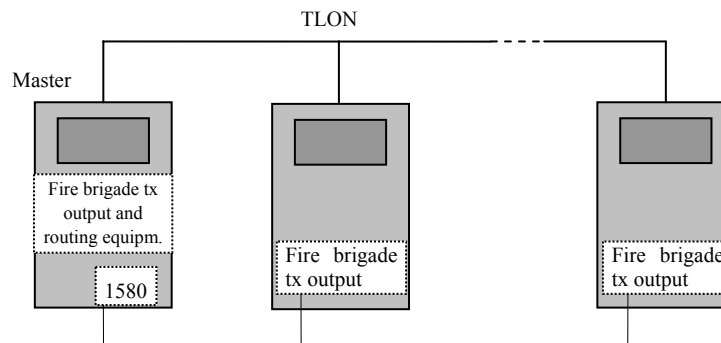

*Figure 27. **Master and slaves.** Several control units (slaves) connected in parallel and connected to one input in the master. One 1580 board input or one 3361 unit input (Input 0) is used.*

17.2.1 Master unit

The control unit containing the fire alarm routing equipment is called the "**Master**".

The master has to be equipped with one 8 zones expansion board 1580 or one I/O unit 3361 (Input 0). All the other control units (slaves) in the system (connected in parallel) have to be connected to **one** zone line input.

One zone line input used for this purpose (on the 1580 board or the 3361 unit), has to be programmed as "Alarm from CU" (i.e. type 3 and type 25 respectively).

17.2.2 Several control units (slaves)

All control units (slaves), i.e. the non-programmable outputs for fire alarm routing equipment (fire brigade tx), have to be connected in parallel and connected to **one** "Alarm from CU" input in the master. The outputs are connected in parallel, like several alarm points, with an end-of-line resistor in the last unit:

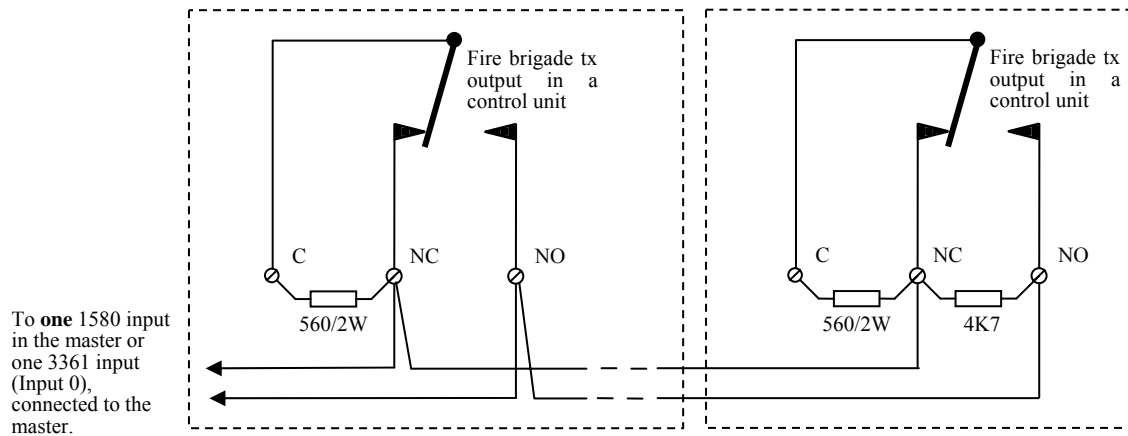

Figure 28. The output for fire alarm routing equipment (fire brigade tx) in several control units (slaves) connected in parallel. Relay contacts shown in quiescent condition. One alarm resistor (560Ω / 2W) shall be connected in each control unit and one end-of-line device (a resistor 4K7 for a 1580 input and a capacitor 470 nF for a 3361 input) shall be connected in the last control unit on the line, according to the figure.

Control unit (slave)

The output for fire alarm routing equipment (fire brigade tx) in any control unit (slave) will be activated¹⁴¹ as follows:

- **No fault** on the TLON network **AND** fire alarm in the system.

or

- **Fault** on the TLON network (a single open circuit (cut-off) or single short circuit) **AND** fire alarm activated by the control unit itself.

Master

The output for fire alarm routing equipment (fire brigade tx) in the master will be activated¹⁴¹ as follows:

- Fire alarm in the system.

or

- **Fault** on the TLON network **AND** fire alarm activated by any control unit (slave), which will be specially presented, see below.

or

- **No fault** on the TLON network **AND** fire alarm activated by any control unit (slave) **AND** no other fire alarm in the

¹⁴¹ Also normal fire alarm indication, activation of outputs etc.

system. (In this case also a fault will be generated, see below.)

The input in the master will be "blocked" as follows:

- **No fault** on the TLON network **AND** Fire alarm in the system.

Presentation of fire alarm from several control units (slaves)

In the master, a fire alarm activated by any of the other control units (slaves) will be presented as in the following example:

```
POINT: 999-99                               No.:001
User definable text message
```

The zone number "999" indicates that the fire alarm is activated by a control unit. The address "99" indicates several control units (slaves) connected in parallel. The user definable text message may be used to indicate that the alarm originates from one or more CU:s (slaves).

Presentation of fault from several control units (slaves)

An open circuit (cut-off) or short circuit on the input in the master will generate a fault and a fault message as follows (depending on which unit is used):

```
FAULT:Cut-off input n,1580 board b, CU xx
```

```
FAULT:Sh-circ input n,1580 board b, CU xx
```

n = zone line input (0-7) on the 1580 board.

b = 1580 board no. (0-5) in the master.

xx = control unit no. (00-29) of the master.

or (for a 3361 unit, Input 0)

```
FAULT: Zone line input, tech no xxxxxx
```

xxxxxx = Technical number for the 3361 unit (Input 0)

No fault on the TLON network **AND** fire alarm activated by any control unit (slave) **AND** no other fire alarm in the system will, besides the fire alarm, generate a fault and a fault message as follows (depending on which unit is used):

```
FAULT: Alarm input n,1580 board b, CU xx
```

n = zone line input (0-7) on the 1580 board.

b = 1580 board no. (0-5) in the master.

xx = control unit no. (00-29) of the master.

or (for a 3361 unit, Input 0)

```
FAULT: Alarm input, tech no xxxxxx
```

xxxxxx = Technical number for the 3361 unit (Input 0)

18 Cyber sensor functions

The latest generation of detectors are the "Cyber sensors".

The Cyber sensor "family" consists of the following detectors:

- Conventional photoelectric smoke detector 4352
- Conventional multi detector 4350
- Analog photoelectric smoke detector 4301
- Analog multi detector 4300

NOTE! NOTE! NOTE! NOTE! NOTE! NOTE! NOTE! NOTE!

The detectors **4301** and **4300** can via the address setting tool 3314 be set in NORMAL, 2330 or 2312 mode. **In the NORMAL and 2312 modes the detector functions are like the current 33xx and 23xx detectors respectively**, since they are intended to be replacements for those detectors. See chapters "COM loop units", page 35 and "Functions / Services / Features", page 93.

In 2330 mode they work as conventional detectors.

The detectors **4352** and **4350** uses some of the cyber sensor functions. See the function respectively below.

The detectors are prepared for an "Advanced mode", which might be used in conjunction with a future EBL512 S/W version.

The **AI function** is used to secure the real fire alarms but also to reduce the false (nuisance) alarms with up to 46 %. The AI function is depending on if the detector is a photoelectric smoke detector (4301) or a multi detector (4350 / 4300):

Combined heat and smoke sensing will guarantee reliable and accurate fire alarm detection, e.g. by shortening the delay time and/or raise the sensitivity (i.e. lower the alarm threshold level).

Fire alarm activation in conjunction with temperature rise.

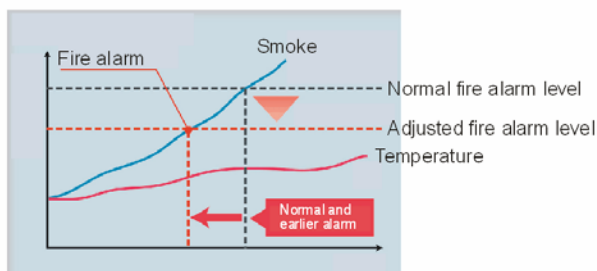

By combined smoke and heat sensing a lower fire alarm level can be used.

Variable delay time. The delay time is influenced by the temporary temperature and/or smoke obscuration changes just before and after the alarm threshold level was passed. The delay time before a fire alarm is activated can be shortened up to 50 % (e.g. from 20 to 10 sec.), or the delay time can be extended in order to reduce false (nuisance) alarms.

Learning function / conditions. The detector will adapt a learning condition depending on the long-time influence of smoke and/or the temperature where the detector is located.

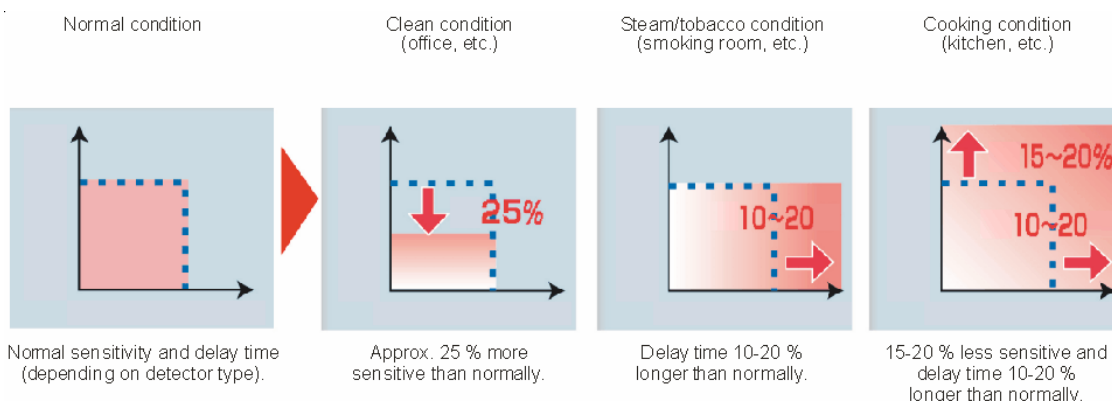

18.1 Pulse up – down counter

The detector have a "pulse up – down counter", starting at "0" and can not be negative.

18.1.1 Pulse up – down counter for smoke

When the smoke obscuration S (%/m) \geq the alarm threshold level, "1" is added to the counter (every second).

When $S <$ the alarm threshold level, "2" is subtracted from the counter (every second).

18.1.2 Pulse up – down counter for temperature

When the temperature T ($^{\circ}\text{C}$) \geq the alarm threshold level, "3" is added to the counter (every second).

When the temperature rise ΔT ($^{\circ}\text{C}/168\text{sec.}$) \geq the alarm threshold level, "3" is added to the counter (every second).

When T or $\Delta T <$ the alarm threshold level, "2" is subtracted from the counter (every second).

18.1.3 Pulse up – down counter for smoke & temperature

When $2S + \Delta T \geq$ the alarm threshold level, "1" is added to the counter (every second).

When $2S + \Delta T <$ the alarm threshold level, "2" is subtracted from the counter (every second).

18.2 Fire judgement

The fire judgement is depending on different functions for the different detector types and if the cause of alarm is smoke S , temperature T or ΔT or a combination of smoke and temperature $2S + \Delta T$.

When the counter shows "9" (i.e. at the earliest after nine seconds in case of S or $2S + \Delta T$ and after three in case of T or ΔT) the following will happen:

4352: Fire alarm is activated.

4350: Depending on the AI function (learning condition, temperature condition, etc.) a delay time has to run out before fire alarm is activated.

4301: Depending on the mode and the AI function (learning condition, etc.) a delay time has to run out before fire alarm is activated.

4300: Depending on the mode and the AI function (learning condition, temperature condition, etc.) a delay time has to run out before fire alarm is activated.

18.3 Alarm threshold levels

Depending on the detector type, mode and learning condition there are alarm threshold levels (**S**, **T**, **deltaT** and **2S+deltaT**) for pre-warning, fire alarm and heavy smoke / heat alarm.

The following fire alarm threshold levels are valid for the different type of detectors:

4352:

Learning condition	S[%/m]
	Fire alarm
Normal	4

4350:

Learning condition	S[%/m]	T[deg.]	deltaT [deg./168sec]	2S+deltaT #2
	Fire alarm	Fire alarm	Fire alarm	Fire alarm
Normal	5	57	18	12
Steam/tobacco	5	57	18	12
Clean	3.7	57	18	10
Heating	5	57	no use	12
Cooking	5	57	18	14

#2 NOTE! $S \geq 2.5$ (%/m) and $\text{deltaT} \geq 3$ (°C/168 seconds).

4301 (in 2330 mode):

Learning condition	S[%/m]
	Fire alarm
Normal	3.5

4300 (in 2330 mode):

Learning condition	S[%/m]	T[deg.]	deltaT [deg./168sec]	2S+deltaT #2
	Fire alarm	Fire alarm	Fire alarm	Fire alarm
Normal	5	57	18	12

#2 NOTE! $S \geq 2.5$ (%/m) and $\text{deltaT} \geq 3$ (°C/168 seconds).

18.4 Learning function / Learning conditions

Depending on the local temperature changes and the local occurrence of smoke where the detector is situated, each detector can after a

learning period, adapt a more appropriate alarm algorithm than the normal one, a **learning condition**. See also page 126.

18.4.1 Learning conditions

Each detector starts in the Normal condition. There are four learning conditions that can be adapted:

- Steam / tobacco condition, depending on the occurrence of smoke, i.e. **level 1** = $S \text{ [%/m]} \geq \text{half the fire alarm threshold level (S)}$.
- Heating condition, depending on rise of temperature, i.e. **level 2** = $\text{deltaT [}^\circ\text{C/168 sec.]} \geq 12$ (approx. 4.3°C/min.).
- Cooking condition, depending on the occurrence of smoke together with rise of temperature, i.e. **level 3** = $2S + \text{deltaT} \geq 10$. **NOTE!** S has to be ≥ 2.5 and deltaT has to be ≥ 3 .
- Clean condition, the most sensitive condition requiring very clean and stable environment, i.e. the values for all the other conditions (level 1, 2 and 3) must not be exceeded.

18.4.1.1 Steam / tobacco condition, level 1

36h	36h	36h	36h	36h	36h	36h	36h	36h	36h	36h	36h	36h	36h	36h	36h	36h	36h	36h	36h
		✓	✓						✓										
1	2	3	4	5	6	7	8	9	10	11	12	13	14	15	16	17	18	19	20

In a **learning period** there are twenty **36h-periods** (i.e. 20 x 36h = 720h = 30 days = one month).

During each **36h-period** it is recorded if **level 1** is exceeded at least one time. If so, the **36h-period** will get a check-mark (see example).

If three or more of the 36h-periods during the **learning period** have a check-mark, the Steam / tobacco condition will be adapted. In the example this happens in the **36h-period** no. 10 (i.e. after 10 x 36h = 360h).

After the **36h period** no. 20, the next **learning period** starts again in the **36h period** no. 1. The check-marks are inherited from the previous **learning period**. Depending on if **level 1** is exceeded during the **36h period** respectively or not, there will be a check-mark or no check-mark.

36h	36h	36h	36h	36h	36h	36h	36h	36h	36h	36h	36h	36h	36h	36h	36h	36h	36h	36h	36h
			✓						✓										
1	2	3	4	5	6	7	8	9	10	11	12	13	14	15	16	17	18	19	20

In the example, the Steam / tobacco condition will be ended after the **36h period** no. 3, since there are left only two **36h periods** with check-marks in the **learning period** now. (If later, one or more **36h**

periods will get a check-mark, the Steam / tobacco condition will be adapted again as long as three or more of the **36h-periods** during the learning period have a check-mark.)

18.4.1.2 Heating condition, level 2

The learning function is the same as for the Steam / tobacco condition, **level 1**.

18.4.1.3 Cooking mode, level 3

The learning function is the same as for the Steam / tobacco condition, **level 1**.

18.4.1.4 Clean condition, level 1, 2 & 3

For this learning condition to be adapted there must be no check-mark for **level 1**, **level 2** and **level 3** respectively during the **learning period**, i.e. no check-mark what so ever.

The **Clean condition** will be ended directly if any **36h period** for **level 1**, **level 2** and **level 3** respectively gets a check-mark, i.e. any check-mark what so ever.

18.4.1.5 Learning condition summary

A detector can adapt the following **learning conditions**, depending on if and when **level 1**, **level 2** and **level 3** are exceeded or not:

Normal condition (default)

or

Clean condition

or

Steam / tobacco condition and/or **Heating condition** and/or **Cooking condition**

The following is valid for the different type of detectors:

4352: This detector uses not the Learning function.

4350: This detector uses the Learning function (for different alarm threshold levels and alarm delay times, depending on smoke & temp.).

4301: This detector uses not the Learning function.

4300: This detector uses not the Learning function.

18.5 Alarm delay time

Depending on the detector type, mode and learning condition the delay times before fire alarm threshold level was exceeded, are for the different type of detectors:

4352: Normally 9 seconds.

4350:

The cause of alarm Learning condition	Delay time[sec]				
	S		T	deltaT	2S+deltaT
	data1[%/m]				
Normal	< 0.6	39	15	15	data2/2 #3
	0.6 <=, < 0.8	30			
	0.8 <=, < 2.5	18			
	2.5 <=	9			
Steam/tobacco	< 0.6	39+data2/2 #3	15	15	data2/2 #3
	0.6 <=, < 0.8	30+data2/2 #3			
	0.8 <=, < 2.5	18+data2/2 #3			
	2.5 <=	9+data2/2 #3			
Clean	< 0.3	39	15	15	data2/2 #3
	0.3 <=, < 0.4	30			
	0.4 <=, < 1.3	18			
	1.3 <=	9			
Heating	< 0.6	39	15	no use	data2/2 #3
	0.6 <=, < 0.8	30			
	0.8 <=, < 2.5	18			
	2.5 <=	9			
Cooking	< 0.6	39	15	15	data2' #3
	0.6 <=, < 0.8	30			
	0.8 <=, < 2.5	18			
	2.5 <=	9			

#3 NOTE! Max. alarm delay time is 60 seconds.

data1 = The average smoke obscuration value (S) for 60 seconds before the alarm threshold level was passed.

data2 = The sum of the difference between the smoke obscuration value (S) and the alarm threshold level every second for nine seconds after the counter shows "9".

data2' = The sum of the difference between the 2S+deltaT value and alarm threshold level every second for nine seconds after the counter shows "9".

4301 (in 2330 mode):

The cause of alarm Learning condition	Delay time[sec]	
	S	
	data1[%/m]	
Normal	< 0.2	42
	0.2 <=, < 0.3	39
	0.3 <=, < 0.4	30
	0.4 <=, < 1.3	18
	1.3 <=	9

4300 (in 2330 mode):

The cause of alarm Learning condition	Delay time[sec]				
	S		T	deltaT	2S+deltaT
	data1[%/m]				
Normal	< 0.6	42	9	9	data2/2 #3
	0.6 <=, < 0.8	30			
	0.8 <=, < 2.5	18			
	2.5 <=	9			

#3 NOTE! Max. alarm delay time is 60 seconds.

18.6**Analog data output**

The smoke obscuration value (%/m) and the temperature (°C) can be shown via the c.i.e. A new value is calculated every second. (The smoke obscuration value is an average value for the last four seconds.)

The following is valid for the different type of detectors:

4352: This detector has no analog output.

4350: This detector has no analog output.

4301: This detector has a smoke obscuration value output in the NORMAL and 2312 modes.

4300: This detector has a smoke obscuration value output and a temperature value output in the NORMAL mode.

18.7 Sensitivity compensation

In order to maintain a constant sensitivity regardless of the contamination of the detector, a Contamination Compensation Factor (CCF) is calculated during a 36 hours period as follows:

During 13 minutes, all smoke obscuration values are saved and an average value is calculated. The CCF will be changed if it is lower than the actual CCF, else no change.

After 18 hours, the CCF will be changed if it is lower or higher than the actual CCF. (It will normally be higher by contamination.)

After 18 hours more (totally 36 hours) the CCF will be changed if it is lower or higher than the actual CCF and it will be saved in the detector's EEPROM, so it can be used e.g. after the detector has been without power supply. A new 36 hours period starts.

Max. compensation is 2 %/m. A service signal will then be activated and shown in the c.i.e.

The following is valid for the different type of detectors:

4352: This detector has no sensitivity compensation.

4350: This detector has sensitivity compensation (but no service signal output).

4301: This detector has sensitivity compensation in the 2330 mode (but no service signal output).

4300: This detector has sensitivity compensation in the 2330 mode (but no service signal output).

18.8 Self diagnosis of internal devices

The detectors perform an internal check of some vital functions and components (e.g. the IR-LED). In some modes a separate fault message will be shown in the c.i.e.

The following is valid for the different type of detectors:

4352: This detector has no self diagnosis of internal devices.

4350: This detector has self diagnosis of internal devices (but no separate fault output).

4301: This detector has self diagnosis of internal devices (but no separate fault output in 2330 mode).

4300: This detector has self diagnosis of internal devices (but no separate fault output in 2330 mode).

18.10 Address setting check

The indication LED in the detectors **4301** and **4300** in all modes will when power supplied blink every second when the detector's address is "000". Normally it should be an address in the interval 001-127.

19 Control unit properties (settings)

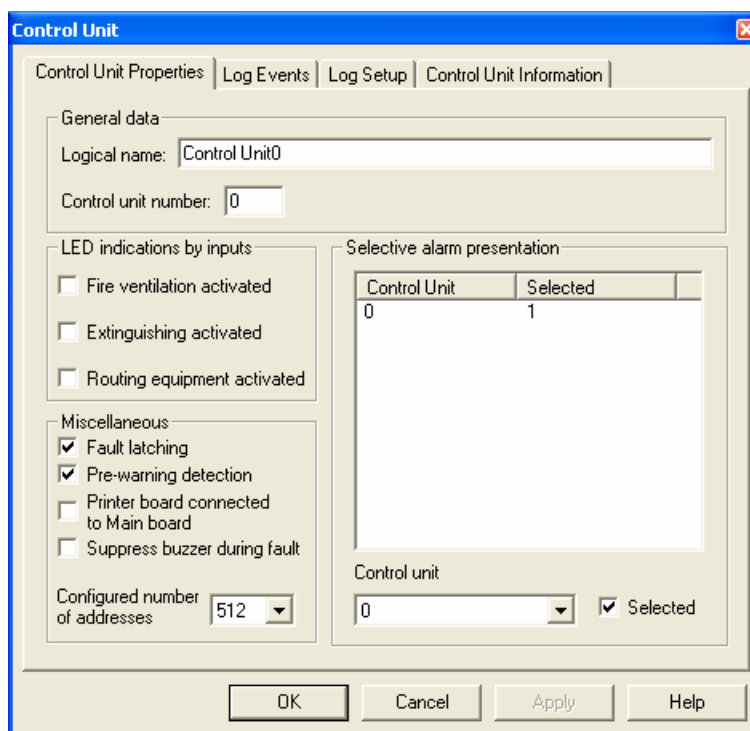

Figure 29. Win512 "Control unit" dialog box.

NOTE! Default settings in Win512 are shown but might vary depending on convention.

19.1 Control unit data

19.1.1 General data

Logical name: Normally not changed (but can be changed when necessary).

Control unit number: A stand-alone control unit has no. 00. In a system the control units are numbered 00 to 29.

19.1.2 LED indications by inputs

Normally the LED indicators listed below will be lit when a corresponding output is activated¹⁴². When selected, the LED will be turned on when a programmable input is activated instead, e.g. a feedback from a fire brigade tx output can activate a programmable input to turn on the LED "Fire brigade tx".

- Fire ventilation activated:** LED "Ventilation"
- Extinguishing activated:** LED "Extinguishing"
- Routing equipment activated:** LED "Fire brigade tx"

¹⁴² Type of output = Extinguishing, Fire ventilation and Routing equipment respectively.

19.1.3

Miscellaneous

- Fault latching** (default): all faults, also corrected faults, have to be acknowledged. No fault latching = not corrected faults have to be acknowledged but corrected faults have not to be acknowledged.
- Pre-warning detection**: The pre-warning detection in a control unit is enabled as default. When disabled, pre-warnings activated in other control units in the system will always be presented in all control units and all programmable outputs in the system, with trigger condition pre-warning, will be activated (if not disabled). Fire alarm will always activate all programmable outputs in the system, with trigger condition pre-warning.
- Printer board connected to Main board**: This check box shall be marked when the c.i.e. has a built-in printer (i.e. EBL512 type number 1549).
- Suppress buzzer during fault**: This check box shall be marked when faults generated in other control units shall be suppressed in this control unit, i.e. the buzzer will only be turned ON for faults generated in this control unit.

Configured number of addresses: 128, 256 or 512. Shall be set to the same as in EBL512 settings ("Max. loop units"). This setting is used when programming alarm points in Win512. When doing a validation check you will get a message if too many alarm points have been programmed in relation to the settings. (This check is automatically performed when downloading the SSD to the c.i.e.)

19.1.4

Selective alarm presentation

In a system (i.e. two or more control units in a TLON network) it is possible to choose which control units' fire alarms¹⁴³ that shall be presented in the control unit respectively.

Default = All fire alarms will be presented in all control units. In each "Control unit" dialog box, the control units that shall not be presented in that control unit have to be **de-selected**.

Example: A system with four Control Units (C.U. 0, 1, 2 and 3). In C.U. 0 shall only fire alarms from C.U. no. 0 be presented and in C.U. 1, 2 and 3 shall all fire alarms be presented.

How to de-select a control unit: Select a control unit in the "Control unit" drop down list box (e.g. 1) and empty the "Selected" check box (on the right side). Click the "Apply" button and Selected = 1 changes to Selected = 0.

This has to be done for control units 2 and 3 also.

¹⁴³ Activated by alarm points, etc. connected to a control unit.

"Control unit" dialog box for control unit 0. Control units 1,2 and 3 are de-selected:

Control unit	Selected
0	1
1	0
2	0
3	0

"Control unit" dialog box for control unit 1, 2 and 3 respectively. No control unit is de-selected:

Control unit	Selected
0	1
1	1
2	1
3	1

19.2

Log events

The general event log can be shown / printed out via menu H4/U7 or via Win512. The following events are all selected by default.

- Alarm (All alarms; pre-warning, fire, etc.)
- Reset alarm (All alarm resets)
- Disablement (except via time channel) (All disablements except those via time channels)
- Re-enablements (All re-enablements except those via time channels)
- Fault (All faults)
- Acknowledge fault (All acknowledged faults)
- Fault serviced (All corrected faults)
- Service signal (All analog smoke detectors having activated service signal)
- Acknowledge service signal (All service signal acknowledges)
- Test mode activation and de-activation (Test mode ON / OFF)
- Programming misc. (functions under H5) (Actions done via menu H5)
- Open/Closed door (CU/ext. FBP) (All opened / closed doors)

- Activated outputs (All activated outputs)
- Downloading SSD (Download of site specific data via Win512)
- Interlocking (Activated interlocking output / input)

19.3 Log setup

All event log setups are made in Win512. Default setup is normally used.

NOTE!

A fixed memory area is dedicated for all logs. Depending on type of log(s), how many and which events that are to be logged, etc. you might get a "Limits exceeded" warning in Win512.

Date & Time are stored together with every event.

For more information, see Win512 help. Regarding circular logging:

- Circular logging:** The log re-starts when it is "full". The first events will be overwritten, i.e. a circular log shows the xx latest events.
- Circular logging:** Not circular logging = straight logging = the log stops when it is full and has to be erased before the logging can start again, i.e. a straight log shows the xx earliest events.

19.3.1 General event log

What will be logged is selected in the "Event Logs" tab. The log can be shown via EBL512 (menu H4/U7) or via Win512 (the Control unit pop-up menu | Show General Event Log).

Number of recorded logs: Default is 150 events. 0-214 is possible.

- Circular logging**

19.3.2 Sensor log

Only analog smoke detectors (sensors) having reached the pre-warning level or the sensor value zero will be logged. This information (techn. no. and sensor value) is useful when commissioning an installation or is used by service engineer for troubleshooting.

NOTE! The Sensor log can be shown in a future Win512 version only.

Number of recorded logs: Default is 20 events. 0-20 is possible.

From technical number: Interval start number. Normally (default) number 000000.

To technical number: Interval stop number. Normally (default) number 293127 (i.e. the highest possible technical number for a COM loop unit in a system).

- Circular logging**
- Min/max log:** Each analog detectors' min. and max. sensor value respectively will be logged if the checkbox is marked.

NOTE! The Min/max log can be shown in a future Win512 version only.

19.3.3

Communication error log

Communication error occurring on the COM loops will be logged together with the technical number.

NOTE! The Communication error log can be shown in a future Win512 version only.

Number of recorded logs: Default is 15 events. 0-15 is possible.

Circular logging

19.4

Control unit information

In this tab you can **read** the following information:

Logical name

Control unit (number)

No. of expansion cards

No. of addresses

No. of alarm points (detectors in conventional zones excluded)

No. of alarm points (detectors in conventional zones included)

No. of zones

When a name / number / unit is changed, added or removed, this information will be updated.

20 System properties (settings)

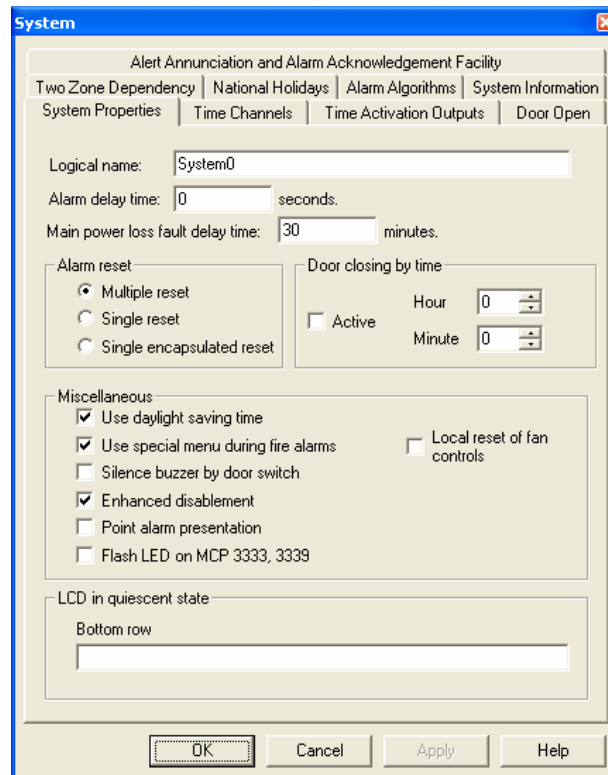

Figure 30. Win512 "System" dialog box.

NOTE! Default settings in Win512 are shown but might vary depending on convention.

20.1 System data

20.1.1 Logical name

Normally not changed but each system can have a unique name.

20.1.2 Alarm delay time

The fire alarm delay time is set here for the detectors with this option selected via Win512. Default is "0" and up to 127 seconds can be set. **NOTE!** This delay starts when the alarm normally should have been activated, i.e. it will be added to all other delay times (e.g. after an L-/N-/H-35 algorithm).

20.1.3 Main power loss fault delay time

A fault will be activated 30 minutes (default) after loss of mains (230 V AC). 0 – 300 minutes can be set.

20.1.4 Alarm reset

One of the following alternatives can / shall be selected.

- ⊙ **Multiple reset** (default): All activated fire alarms in the system will be reset simultaneously by pressing the "Reset" button.

- **Single reset:** One activated fire alarm in the system, shown in the control unit's alphanumeric display on the first row to the left, will be reset by pressing the "Reset" button, i.e. all activated fire alarms have to be reset one by one. This function is a violation to the EN54-2 standard.
- **Single encapsulated reset:** Encapsulation function. This function is a violation to the EN54-2 standard.

Encapsulation function: If an alarm point / zone is reset while still in alarm state (e.g. smoke in a smoke detector or a manual call point with a broken glass) this unit will be automatically disabled in order not to activate a new fire alarm within 20 seconds. It will stay disabled until re-enabled via menu H2/B5.

LED "Disablements" is indicating one or more disablement in the system.

20.1.5 Door closing by time

- **Active:** If all fire doors shall be closed at a definite time every day, this checkbox shall be marked.
Hour: 00 – 23
Minute: 00 - 59

20.1.6 Miscellaneous

- ☒ **Use daylight saving time:** According to the current EU regulations, i.e. it starts last Sunday in March 01:00 GMT one hour ahead¹⁴⁴ and stops last Sunday in October 01:00 GMT one hour backwards.¹⁴⁵
- ☒ **Use special menu during fire alarms:** During the fire alarm presentation, a special fire alarm menu can be used. (If this menu is excluded it is a violation to the EN54-2 standard). See also EBL512 Operating instructions, chapter "Fire alarm menu".
- **Silence buzzer by door switch:** If the buzzer in the c.i.e. shall be silenced when the door is opened, this checkbox shall be marked¹⁴⁶ but this is a violation to the EN54-2 standard.
- ☒ **Enhanced disablements:** Checkbox marked = Disabled alarm points will not activate pre-warning, fire alarm or fault.
Checkbox not marked = Disabled alarm points will not activate pre-warning or fire alarm but fault can be activated. This is a violation to the EN54-2 standard.
- **Point alarm presentation:** If fire alarms shall be presented the same way as in EBL512 S/W version \leq 1.43.x (i.e. Zone – Address for all fire alarms), this checkbox shall be marked but this is a violation to the EN54-2 standard.

¹⁴⁴ I.e.: 02:00 one hour ahead to 03:00.

¹⁴⁵ I.e.: 03:00 one hour backwards to 02:00.

¹⁴⁶ Required when the "old" front is used.

- Flash LED on MCP 3333, 3339:** The manual call point's built-in LED will flash each time the c.i.e. communicates with the call point. If this option is disabled the LED is switched off until the call point is operated.
- Local reset of fan controls:** Checkbox marked = Reset of fan control system is **local**, i.e. all fan control systems in the c.i.e. where the switch is located will be reset.
Checkbox not marked = Reset of fan control system is **global**, i.e. all fan control systems in the system will be reset. (Fan control, see page 55.)

20.1.7 LCD in quiescent state

Bottom row: The text to be shown on the bottom (second) row in the LCD in all control units in the system, when the system is in quiescent state, e.g. the name of the installation. Max. 40 characters. (The top (first) row in the LCD, which will show the date, time, EBL512 and the control unit number, is **not** possible to edit.)

20.2 Time channels

The control unit RTC (real time clock) controls time channels 1-14.

Time channels can be used to:

- disable and re-enable alarm points
- set alert annunciation ON / OFF
- activate programmable control outputs
- set alternative alarm algorithm for analog detector types 33xx /430x ON / OFF
- set 2-unit dependence function ON / OFF

The properties for each **Time channel** (1-14) and each **Day of the week** (1-8) have to be set for the channels that shall be used.

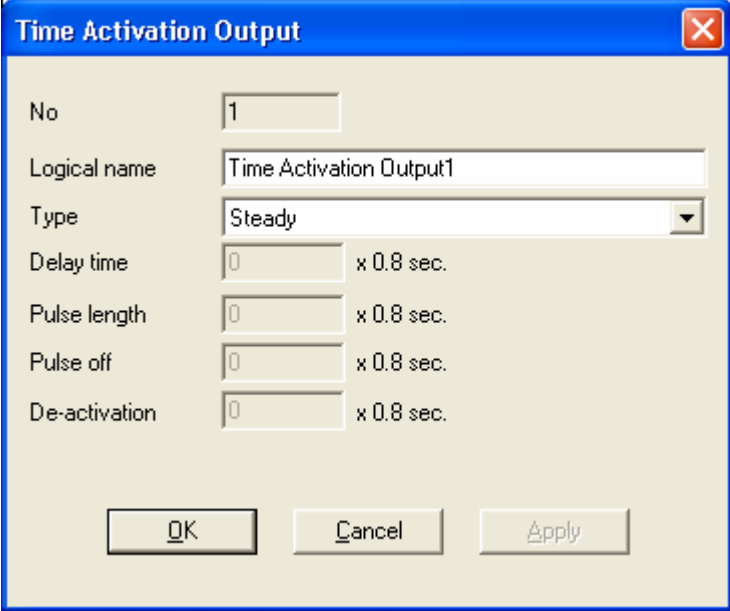

*Figure 31. Properties for one time channel and one day. Day of week 1 = Monday. Day of week 8 = National holiday.
 = On. = Off.*

All (52) weeks of a year have the same settings. When a national holiday appears in the middle of a week, separate ON/OFF times can be set for that holiday, i.e. the day of the week = 8. The National holiday dates have to be set separately in the "National holidays" tab.

20.3 Time activation output

See also chapter "Time activation", page 78.



"Time Activation Output" 1-10 can be programmed. For each Time Activation Output the properties have to be set:

No.: X = The number of the Time Activation Output, 1-10. Information only, can not be changed.

Logical name: Normally not changed but each Time Activation Output can have a name indicating what it is meant for, e.g. "Alarm devices".

Type: Steady (continuous), Intermittent, One pulse, Steady – delayed activation, Intermittent - delayed activation, One pulse - delayed activation **or** Steady – delayed de-activation.

Delay time: Can be set, when required, to 0-255 x 0.8 sec.

Pulse length: Can be set, when required, to 0-255 x 0.8 sec.

Pulse off: Can be set, when required, to 0-255 x 0.8 sec.

De-activation: Can be set, when required, to 0-255 x 0.8 sec.

Min. = 1 x 0.8 = 0.8 sec. Max. = 255 x 0.8 = 204 sec. = 3 min. 24 sec.

20.4 Door open

20.4.1 Indication door open affected by

NOTE! The Ext. FBP types 1826 & 1828 do not have any LED "Door open", i.e. there is no "Door open" indication in these units.

- ⊙ **Door in any control unit or any external FBP** (default): Door open in a C.U. is indicated by LED "Door open" / "Key switch" in all C.U:s and in all ext. FBPs. Door open in an ext. FBP is indicated by LED "Door open" / "Key switch" in all C.U:s and in all ext. FBPs.
- **Door in any control unit:** Door open in a C.U. is indicated by LED "Door open" / "Key switch" in all C.U:s and in all ext. FBPs. Door open in an ext. FBP is indicated by LED "Door open" / "Key switch" in that ext. FBP only.
- **Door in control unit or external FBP connected to own control unit:** Door open in a C.U. is indicated by LED "Door open" / "Key switch" in the C.U. and all ext. FBPs connected to that C.U. Door open in an ext. FBP is indicated by LED "Door open" / "Key switch" in the C.U. and all ext. FBPs connected to that C.U.
- **Door in control unit:** Door open in a C.U. is indicated by LED "Door open" / "Key switch" in the C.U. and in all ext. FBPs connected to that C.U. Door open in an ext. FBP is indicated by LED "Door open" / "Key switch" in that ext. FBP only.

20.4.2

Disablement of routing equipment

- ⊙ **No disablement** (default): Door open in a C.U. or an ext. FBP will **not** disable the outputs for routing equipment (Fire brigade and fault tx).
- **Disable by door in any control unit:** Door open in any C.U. will disable the outputs for routing equipment (Fire brigade and fault tx) in all C.U:s.
- **Disable by door in any control unit or any external FBP:** Door open in any C.U. or any ext. FBP will disable the outputs for routing equipment (Fire brigade and fault tx) in all C.U:s.

In the display (or via menu H4/U1) is shown (xx = C.U. number):
Fire alarm routing disabled (by open door in CU xx)

20.5

National holidays

Up to twenty national holidays can be set for the whole system.¹⁴⁷ For each national holiday the **Year** (2001-2038), **Month** (01-12) and **Day of the Month** (01-31) has to be set. "Add" to or "Delete" from the **Date** list. "Annual repetition" can be set if a holiday returns the same date every year. (The year will be deleted for these days.)

Function: Normally the Day of week 1-7 ON/OFF times are valid. A national holiday has higher priority, i.e. the Day of week 8 ON/OFF times are valid for this day instead of the normal times.

¹⁴⁷ **NOTE!** ON/OFF times for each time channel (1-14) and day of week = 8 (national holiday) have to be set in the "Time channels" tab.

20.6 Alarm algorithms

For each analog detector programmed (via Win512) is an alarm algorithm selected (and when required an alternative alarm algorithm). A number of algorithm "Properties" are displayed under this tab. Detector type, Logical and Short names can be changed. The Short name (\leq six characters) is shown in menu H4/U5¹⁴⁸. Level 1 or Level 2 can be selected (see chapter "Win512 Tools menu", page 116):

In **Level 1** it is also possible to change: The pre-warning and the heavy smoke / heat alarm algorithm parameters for smoke and heat detectors.

In **Level 2** (a special password is required) it's also possible to change: The fire alarm algorithm parameters for smoke and heat detectors.

20.6.1 Classic smoke detectors' properties

Detector: 2300(ION)
 2210(ION2) = ION2200
 2304(OPT)
 2210(OPT2) = OPT2202
 AUT

Logical name: Classic

Short name: Class

Algorithm parameters: Default values, see table:

	2300	2210	2304	2210	AUT
Offset,	10	20	10	20	45
Offset,	18	35	13	25	60
Offset,	22	45	22	45	100
Sampling	2	2	3	3	1

NOTE! If any of these values are changed it might be a violation to the EN54-2 standard.

Sampling interval:

1 = 3 values over alarm level to activate alarm.

2 = 5 values over alarm level to activate alarm.

3 = 7 values over alarm level to activate alarm.

20.6.2 Heat detectors' (3308, 3309, 3316 and 4300) properties

Detector: 3308(AHD), also valid for 3309
 3316 / 4300 HEAT (AMD), i.e. the heat detector part when decision algorithm is not selected.

Logical name: Class A1, Class A2 (S) or Class B (S).

Short name: A1, A2 or B

Algorithm parameters: Default values, see table:

¹⁴⁸ In "British Standard Marine Application" convention \leq five characters. In this convention, the alarm algorithm can also be changed via menu H4/U5.

	3308 (3309) (AHD)			3316 / 4300 HEAT (AMD)			For 3308 (3309)
	A1	A2	B	A1	A2	B	
Level, Pre-warning	92	100	128	46	50	64	x 0.5° C
Level, Fire alarm	112	120	148	56	60	74	x 0.5° C
Level, Heavy alarm	180	180	180	90	90	90	x 0.5° C
Rise time ^A	8			4			x 0.5° C per min.
Step down ^A	20			10			x 0.5° C

NOTE! If any of these values are changed it might be a violation to the EN54-2 standard.

^A Rate-of-rise > 8 x 0.5 = 4° C per minute gives an alarm level temperature step down of 20 x 0.5 = 10° C

20.6.3 Smoke detectors' (3304, 4301, 3316 and 4300) properties

Detector: 3304 / 4301(OPT)

3316 / 4300 SMOKE (AMD), i.e. the smoke detector part when decision algorithm is not selected.

Logical name: L-15 Low sens. 15s, L-35 Low sens. 35s, N-15 Normal sens. 15s, N-35 Normal sens. 35s, H-15 High sens. 15s and H-35 High sens. 35s.

Short name: L-15- L35, N-15, N-35, H-15 and H-35.

Algorithm parameters: Default values, see table:

	3304 / 4301 (OPT)						3316 / 4300 SMOKE (AMD)					
	L-15	L-35	N-15	N-35	H-15	H-35	L-15	L-35	N-15	N-35	H-15	H-35
Offset, Smouldering	18	18	15	15	12	12	18	18	15	15	12	12
Offset, Pre-warning	26	26	22	22	18	18	26	26	22	22	18	18
Offset, Fire alarm	36	36	30	30	24	24	36	36	30	30	24	24
Level, Heavy alarm	150	150	150	150	150	150	120	120	120	120	120	120
Step value ^A	6	2	5	2	4	2	12	4	10	4	8	4

NOTE! If any of these values are changed or if slow detection time (X-35) and/or low sensitivity (L-xx) is used, it might be a violation to the EN54-2 standard.

^A The "Step value" is used in the alarm algorithm.

20.6.4 Multi detectors' (3316 and 4300 + decision algorithm) properties

Detector: 3316 / 4300 SMOKE (AMD), i.e. the 3316 detector when decision algorithm is selected.

Logical name: Decision algorithm

Short name: Dec (Shown in menu H4/U5.

Algorithm parameters: Default values, see table:

	3316 / 4300 SMOKE
Offset, Smoke Pre-	50
Offset, Smoke alarm	58
Level, Heat Pre-warning	50
Level, Heat alarm	58

NOTE! If any of these values are changed, it might fasten or delay the alarm activation.

20.7 System information

In this tab you can **read** the following information:

Logical name

Number of Control units

Number of addresses

Number of expansion cards

When some name is changed, added or removed units, this information is updated.

20.8 Alert Annunciation and Alarm Acknowledgement Facility

20.8.1 Alert Annunciation

See also chapter "Alert annunciation", page 103.

Acknowledgement time: 30 sec.

30 is default. 5, 10, 15, - -300 (= 5 min.) is possible.

Investigation time: 3 min.

3 is default. 1-40 is possible

Number of zones: 1

1 is default. 1-4 is possible

Multiple alarms allowed within same zone

If only one alarm point within the zone is allowed to activate alert annunciation, this checkbox shall be unmarked.

NOTE! According to EN54-2, the total delay of fire alarm routing equipment (Acknowledge time + Investigation time) must not exceed 10 minutes.

20.8.2 Alarm Acknowledgement Facility

Used in conjunction with the AAF Control, which is available on the Australian market only.

See also chapter "Alarm Acknowledgement Facility (AAF)", page 105.

Acknowledge period (AP) time: 60 sec.
60 is default. 10-60 is possible.

Investigation period (IP) time: 3 min.
3 is default. 1-3 is possible.

20.9 Two zone dependence

See also chapter "2-zone / 2-address dependence (co-incident alarm)", page 102.

Group Zone: A list box displays **all** the so far programmed zones in the system, i.e. the zones have to be programmed in Win512 before they can be programmed to a two-zone dependence group.

NOTE!

Only conventional zones (i.e. zone lines with conventional detectors) should be used in the two-zone dependence function.
For analog / addressable detectors the two-address (unit) dependence function should be used.

Default for all zones is Group 0 (= no two zone dependence).

Click the current group number (0) for the zone to be programmed.

The zone number displays in the **Zone** box (down to the right in the dialog box).

Type the new group number in the **Group** box.

Click "Apply" to accept and update the **Group Zone** list box.

The group number for the zone is now changed which is displayed in the **Group Zone** list box.

NOTE!

When all changes have been done, check so that two or more zones are programmed in each group. (A single zone in a group will never be able to activate any fire alarm!)

21 **Compatibility**

Regarding backwards compatibility:

Analog smoke detector (sensor) types 2200 and 2202 plugged in analog base 2210, can be connected to the COM loops. See Win512 help.

See also chapter "Analog Detectors" (types 33xx), page 40.

Regarding earlier EBL systems (EBL2000 / 1000 / 500), contact PEWF&STE AB for advice.

22 Cable types

A fire alarm installation is a safety installation and it is important that the cables used, are correct types and according to national regulations. Fire alarm cables should, when possible, be installed as far away from other cables as possible, in order to avoid disturbances from these.

The maximum cable length is depending on the cable type (area, twisted / not twisted pairs, screen / no screen), the units' current consumption, etc.

22.1 TLON Network cables

See dwg. 512-49 and separate TLON Technical description.

22.2 COM loop cables

Loop topology is used for highest safety, i.e. the cable, connected in the control unit, returns back to the control unit. In case of a break on the loop, communication in two directions starts. See dwg. 512-41, -51, -52 -53, -61 and -62.

Cable length is depending on number and type of loop units, etc. See chapter "COM loop cable length", page 149 and dwg. 512-01.

ELKY¹⁴⁹ 2 x 1 mm (0.75 mm²) or equivalent (twisted pair).

ELKY¹⁴⁹ 10 x 2 x 1 mm or equivalent, when feeder line is required.

If screened cable is used, the screen shall be connected close to each loop unit and only incoming (or outgoing) screen to the c.i.e. earth point.

22.3 BS4 loop cables

Loop topology is used, see dwg. 512-48.

Normally, you connect an existing installation to the EBL512 control unit (Autronica interface board 1584). If new cables are to be installed, see Autronica BS 100 documentation.

22.4 Ext. FBP / Data converter cables

RS-485. See dwg. 512-47.

Cable length \leq 1200 m to the furthest away situated ext. FBP / Data converter.

LiYCY (TP)¹⁵⁰ 2 x 2 x 0.75 mm² or equivalent (twisted pairs).

¹⁴⁹ Or the halogen-free and flame proof type **ELQYB**.

¹⁵⁰ Or the halogen-free and flame proof type **LIHCH-TP**.

22.5 Conventional zone line cables

See dwg. 512-46, -51, -52, -54, -55, -56 and -57.

Inputs to 8 zones expansion board 1580, Addressable zone interface 2226 / 2335, Addressable IS zone interface 2821, Addressable base 2330 external line and Multipurpose I/O unit 3361.

EKKR¹⁵¹ 2 x 0.6 mm (0.3 mm²) or equivalent. Max. 50 ohm cable resistance (= 400 m cable length).

22.6 Alarm device cables

Alarm devices (sounders, etc.), see dwg. 512-42 and 61.

EKKR¹⁵¹ 2 x 0.6 mm (0.3 mm²) or equivalent.

EKKR¹⁵¹ 10 x 2 x 1 mm (0.75 mm²) or equivalent, when feeder line is required.

22.7 Other cables

External indicator (LED), door release magnets, etc. E.g:

EKKR¹⁵¹ 2 x 0.6 mm (0.3 mm²) or equivalent.

¹⁵¹ Or the halogen-free and flame proof type **ELQRB**.

23 COM loop cable length

The cable length and max. COM loop current, are depending on the number and type of loop units and the cable type, see Figure 32 and Figure 33, page 150 and 151 respectively.

One of the graphs has to be used depending on which type of units that are connected to the COM loop. Start checking the terms below for Graph 1, then Graph 2 and finally Graph 3.

1. Graph with square dots (when "old" conventional smoke detectors requiring ≥ 15 V, are used)

Has to be used when at least one of the following units are used:

2335 / 3361¹⁵² + (2316, 2317, 2318 or 2321 plugged in a 2324)
2330 + (2316, 2317, 2318 or 2321 plugged in 2330 or plugged in a 2324 connected on the external line)

2. Graph with circular dots (when no "old" conventional smoke detectors requiring ≥ 15 V, are used)

Has to be used when at least one of the following units are used:

2235 / 2236
2262 / 2263
2265
2300 / 2304
2276
2226 / 2821
2330 + (4318, 4350, 4352 and all other conventional types **except** 2316, 2317, 2318 or 2321 plugged in base 2330 / 2324)
2335 / 3361¹⁵² + (4318, 4350, 4352 and all other conventional types **except** 2316, 2317, 2318 or 2321 plugged in base 2324.)
2333
2340 / 2341
2210 + (2200 or 2202)

3. Graph with no dots (when only "new" units requiring ≥ 12 V, are used)

Can be used when only the following units are used:

2370 / 4370
3312 / 4313 + (3304, 3308, 3316, 4300 or 4301)
3309
3333 / 3339 / AAFC
3361 Monitored input not used as zone line input (Z)
3364
3366
3377 / 3378 + (3304, 3308, 3316, 4300 or 4301)
4582

Here follow two figures, showing graphs for maximum conductor (wire) resistance and maximum cable length respectively.

¹⁵² The monitored input used as a zone line input (Z).

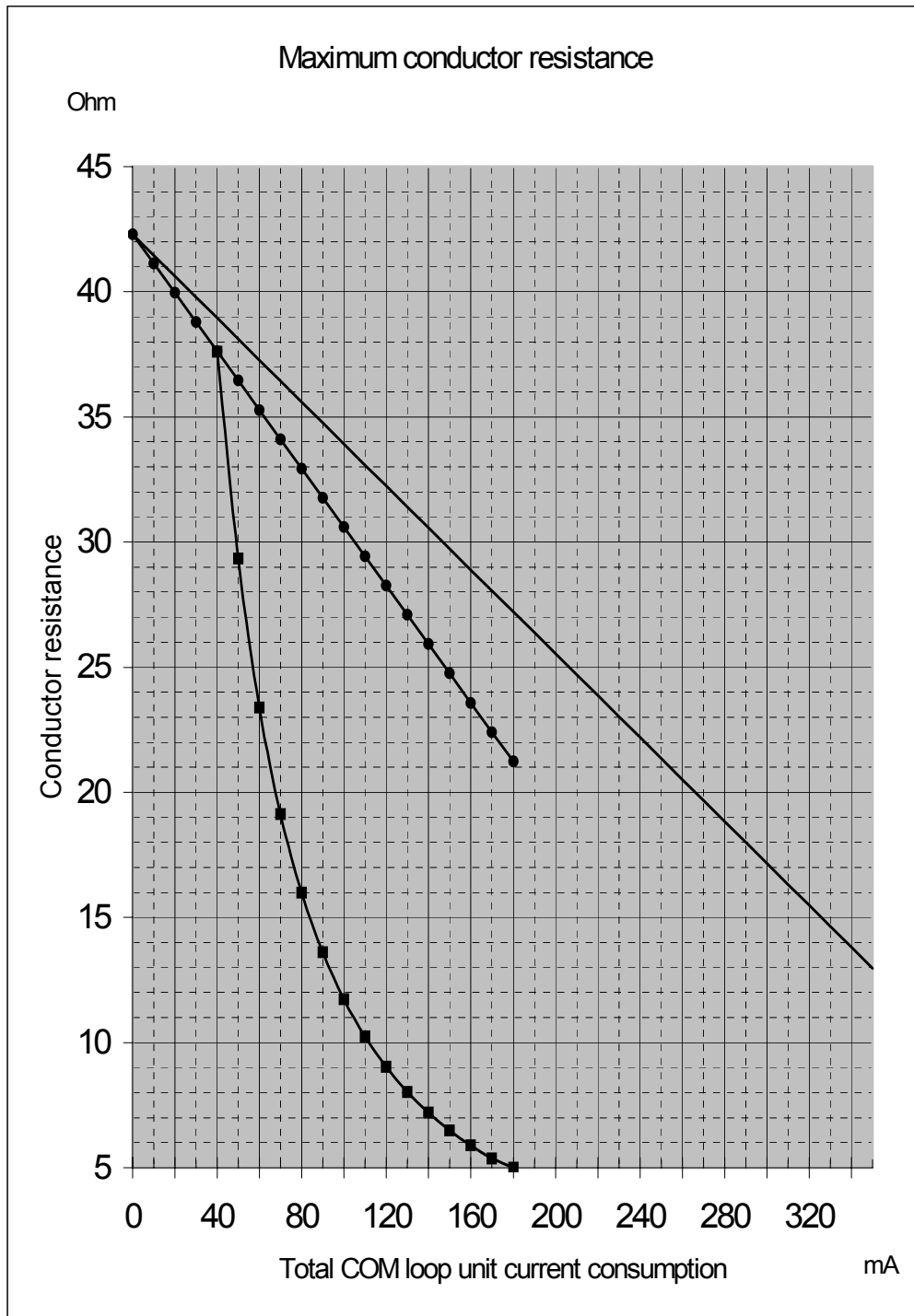
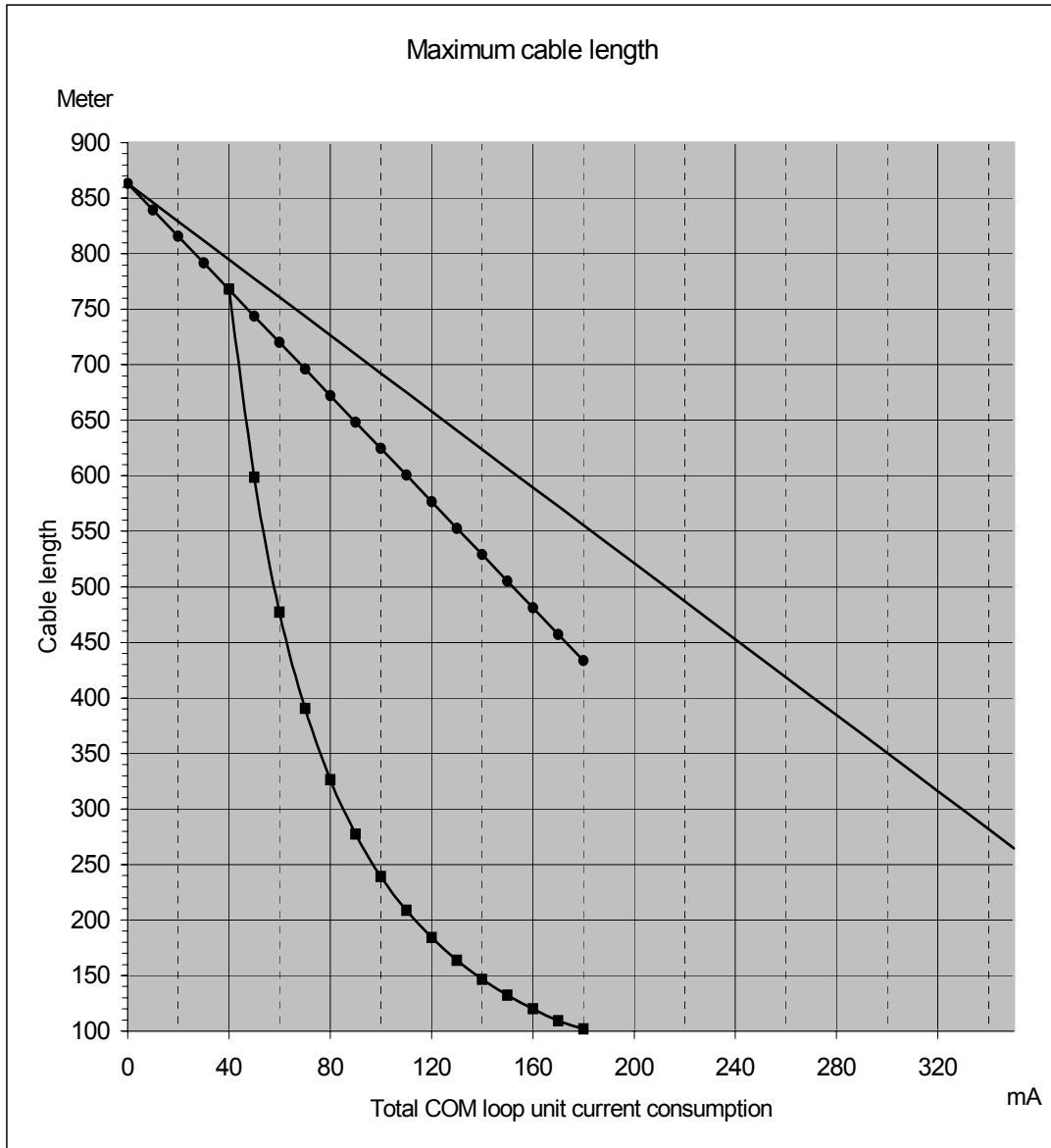

Figure 32. Graphs showing the total conductor resistance in relation to the COM loop units' total current consumption. **NOTE!** The graphs start at "0 mA" (and 42.3 ohm respectively) but graph 1 and 2 ends at "180 mA" and graph 3 ends at "350 mA". End of graph = max. allowed loop current. (42.3 ohm = 863 m cable length.)

NOTE! The graphs are valid for the recommended cable type ELKY (ELQYB) 2 x 1 mm (0.75mm²) with the conductor resistance 24.5 ohm / km. The total conductor resistance (ohm) = L conductor (ohm) + C conductor (ohm).



*Figure 33. Graphs showing the cable length in relation to the COM loop units' total current consumption. **NOTE!** The graphs start at "0 mA" and 863 m cable length respectively but graph 1 and 2 ends at "180 mA" and graph 3 ends at "350 mA". End of graph = max. allowed loop current. (42.3 ohm = 863 m cable length.)*

NOTE! The graphs are valid for the recommended cable type ELKY (ELQYB) 2 x 1 mm (0.75mm²) with the conductor resistance 24.5 ohm / km. The total conductor resistance (ohm) = L conductor (ohm) + C conductor (ohm).

24 Current consumption

The different loop units have different current consumption. Note that some units have much higher current consumption in "active state". To check the current consumption on the COM loops, cable lengths, etc., the tables below can be used. See also dwg. 512-01 and chapter "COM loop cable length", page 149. Also, to get a total current consumption overview and to check if the battery capacity is enough, the tables below can be used.

The current consumption is normally shown at nominal voltage (24 V DC), in **Normal state** (quiescent) and in **Alarm state** (active). By battery back-up (i.e. no mains) the voltage can be 27 – 21 V DC.

See also chapter "Power supply", page 157.

NOTE! A grey row in the tables = outgoing unit, not for new installations and might be no longer in stock.

C.i.e. units		Normal state (quiescent) (mA)	Alarm state (active) (mA)
Control unit (without printer) ¹⁵³	153	180	310
Control unit (with printer) ¹⁵³ 1549	153	200	340
Control unit (without front and without printer) ¹⁵³ 1550	153	160	150
8 zones expansion board 1580		50	50 ¹⁵⁴
8 relays expansion board 1581		15	15
Ext. FBP interface board 1582, no units connected		15	15
German FBP interface board 1583, no units connected		15	15
Autronica interface board 1584 (+ four BS4 loops) ¹⁵⁵	155	55+(4x30)=175	55+(4x60)=295
Ext. FBP / DU interface board 1587, no units connected		15	15
TLON connection board 1590		approx. 20	approx. 20
Web-server 1588		60	65
Web-server II 1598		60	65

¹⁵³ Control unit only, i.e. the current consumptions on each COM loop and other ext. equipment are not included.

¹⁵⁴ When conventional detectors (with alarm resistor) are used, add 65 mA per zone activated. When detectors with a closing contact (short circuit results in a fire alarm) are used, add 86 mA per zone activated.

¹⁵⁵ The board has four BS4 loops. The actual current consumption is depending on the number and types of units connected to each loop. The values in the table are the **max.** values, i.e. 99 units connected to each loop.

COM loop units (input / display units)		Normal state (quiescent) (mA)	Alarm state (activated) (mA)
Analog smoke detector 2300 / 2304 + analog base 2312	¹⁵⁶	1.7 / 1.8	3.7 / 3.8
Analog smoke detector 3304 + analog base 3312	¹⁵⁷	0.3	2.3
Analog heat detector 3308 + analog base 3312	¹⁵⁷	0.3	2.3
Analog heat detector, enclosed 3309	¹⁵⁷	0.2	1.7
Analog multi detector 3316 + analog base 3312	¹⁵⁷	0.55	2.55
Analog multi detector 4300 + analog base 3312	^{157 158}	0.3	2.3
Analog smoke detector 4301 + analog base 3312	^{157 158}	0.3	2.3
Addressable base 2330 + detector. Incl. external line.	¹⁵⁶	1.7 3.5	3.9 13.2 ¹⁵⁹
Addressable heat detector 2340 / 2341	¹⁵⁶	2	5
Addressable zone interface, isolated 2226	¹⁶⁰	3	6
Addressable IS zone interface 2821	¹⁶⁰	3	6
Addressable zone interface 2335		5	20
Addressable 8 inputs unit 2276		2	6
Addressable manual call point 2333		2	5
Addressable manual call point 3333 / 3339		2	5
Alarm Acknowledge Facility Control (AAFC)	¹⁶¹	2	5
Display unit 2235	¹⁶²	12	20
By ext. power supply of the display unit		3	3
Display unit 2236	¹⁶³	12	12
By ext. power supply of the display unit		3	3

NOTE! On each COM loop, up to 5 sensors / detectors can have their LED:s lit at the same time.

¹⁵⁶ Extern LED current consumption. 2216 / 2217: add 1 mA.

¹⁵⁷ Extern LED current consumption. 2216: add 2 mA. 2217: add 1 mA.
Analog base with isolator 4313 can be used instead of Analog base 3312.

¹⁵⁸ This unit might still be under construction.

¹⁵⁹ Alarm state on detector and external line: 15.4 mA

¹⁶⁰ 2226 / 2821 also require external power supply, 24V DC, 30 mA.

¹⁶¹ This unit is available on the Australian market only.

¹⁶² The values in the table show current consumption from COM loop.
(Active: 12 mA + LED "Acknowledge" lit 8 mA = 20 mA). Display backlight requires external 15-28 V, 110 mA (at 15 V).

By external power supply (15-28 V) of the display unit: 12 / 120 mA (at 15 V). LED "Acknowledge" lit: add 8 mA.

¹⁶³ The values in the table show current consumption from COM loop.
Display backlight requires external 15-28 V, 110 mA (at 15 V).

External power supply (15-28 V) of the display unit: 12 / 120 mA (at 15 V).

COM loop units (output units)		Normal state (quiescent) (mA)	Alarm state (activated) (mA)
Addressable short circuit isolator 2370		15	5 ¹⁶⁴
Addressable short circuit isolator 4370		2.2	2.2
Analog base with isolator 4313	¹⁶⁵	≤ 1.3	≤ 1.3
Addressable 4 relay outputs unit 2265		2	2
Addressable 4 outputs unit (with power supply) 2262	¹⁶⁶	6	6
Addressable 4 outputs unit (without power supply) (2263).	¹⁶⁷	6	6
Addressable multipurpose I/O unit 3361		2.2	max. 12 ¹⁶⁸
Addressable 2 voltage outputs unit 3364	¹⁶⁹	≤6	≤6
(Addressable) External power supply 3366		≤15	≤15
Addressable siren 3377	¹⁵⁸	1	max. 13
Addressable sounder base 3378 (low/high)	¹⁵⁸	2	max. 6 / 12
I/O matrix board 4582	¹⁶¹	max. 6	max. 6

¹⁶⁴ By a short circuit approx. 5 mA (that is insignificant in this state).

¹⁶⁵ Detector not included.

¹⁶⁶ The values in the table show current consumption from COM loop. Current consumption (q / a) by battery power supply (24 V): ≤ 350 (≤ 50 after 10 min.) / ≤ 3070 mA (depending on connected equipment, e.g. door release magnets in **quiescent** state and alarm devices in **alarm** state).

¹⁶⁷ The values in the table show current consumption from COM loop. Current consumption (q / a) by 2262 or external power supply (24 V): ≤ 330 (≤ 50 after 10 min.) / ≤ 3070 mA (depending on connected equipment, e.g. door release magnets in **quiescent** state and alarm devices in **alarm** state).

¹⁶⁸ Only if the input In 0 is used as a zone line input, else approx. 2.2 mA.

¹⁶⁹ External 24 V DC power supply also required, e.g. the 3366 unit.

Other units		Normal state (quiescent) (mA)	Alarm state (activated) (mA)
Routing equipment (Fire brigade tx / Fault tx)		Acc. to the producer	Acc. to the producer
External FBP 2425 (with printer)	¹⁷⁰ ¹⁷¹ ¹⁷² ¹⁷³	85	100
External FBP 2426 (without printer)	¹⁷⁰ ¹⁷² ¹⁷³	85	100
External Presentation Display 2428	¹⁷² ¹⁷⁴	36	116
External Presentation unit 1728	¹⁷⁵ ¹⁵⁸	26@24 V / 48@12 V	49@24 V / 88@12 V
Alert Annunciation unit 1735 / 1736	¹⁷⁵ ¹⁵⁸	26@24 V / 48@12 V	42@24 V / 79@12 V
External FBP 1826 / 1828	¹⁷⁵ ¹⁵⁸	26@24 V / 48@12 V	49@24 V / 88@12 V
Printer 1835 (for ext. FBP 1826)	¹⁵⁸	4@24 V / 7@12 V	161@24 V / 345@12 V
Data converter BEST (Nurse call system) 2290	¹⁷²	70	70 ¹⁷⁶
Data converter Tateco (Ascom paging system) 2291	¹⁷²	70	70 ¹⁷⁶
Data converter EBL-talk 2292	¹⁷²	70	70 ¹⁷⁶
Alarm devices (sounders, etc.)		0	Acc. to the producer
Door release magnets		Acc. to the producer	0
Alert annunciation controller 1740		10	40

NOTE! Regarding the 1728, 1735, 1736, 1826, 1828 and 1835 units, see the next page.

¹⁷⁰ FBP display backlight add 100 mA.

¹⁷¹ Active printer add 200 mA.

¹⁷² Normally power supplied from Ext. FBP interface board 1582. When required ext. power supply can be used.

¹⁷³ Regarding External FBP 2425 / 2426: A "new version" (p.c.b. number 2425-3A, CFG: 1) has approx. the same current consumption as External Presentation Display 2428.

¹⁷⁴ The values in the table are valid by 24 V. By 22 V: 37 / 124 mA. By 20 V: 38 / 132 mA. By 18 V: 40 / 145 mA. By 16 V: 42 / 160 mA.

¹⁷⁵ Normally power supplied from Ext. FBP interface board 1582 or Ext. FBP / DU interface board 1587. When required ext. power supply can be used.

¹⁷⁶ Add max. 50 mA per driver output used.

The following table is a **help** when calculating the cable length and/or the number of units connected to one Ext. FBP / DU interface board 1587 (or Ext. FBP interface board 1582)¹⁷⁷. The table is based on the current consumption at the lowest power supply voltage allowed (via the board in the c.i.e.), i.e. 21 V DC by battery back-up (no mains).

Recommended cable type is LiYCY (TP)¹⁵⁰ 2 x 2 x 0.75 mm².
 Wire resistance approx. 25 ohm / 1000 m.

Number of units	Allowed cable resistance (ohm) / length (m)		
	Units 1735 / 1736	Units 1728 / 1735 / 1736 / 1826 ¹⁷⁸ / 1828 ¹⁷⁸ & <u>no printers</u> 1835	Units 1728 / 1735 / 1736 / 1826 / 1828 & <u>one</u> ¹⁷⁹ printer 1835
8	8 / 160	3 / 60	-
7	11 / 220	4 / 80	-
6	17 / 340	10 / 200	-
5	20 / 400	16 / 320	-
4	25 / 500	21 / 420	4 / 80
3	34 / 680	28 / 560	10 / 200
2	50 / 1000	42 / 840	16 / 320
1	100 / max. 1200	84 / max. 1200	18 / 360

Explanation: $8 \text{ (ohm)} \div 25 \text{ (ohm wire resistance per 1000 m)} = 320 \text{ m}$ but the wire goes from the c.i.e. to the last unit and back to the c.i.e. again, i.e. the cable length = $320 \text{ (m)} \div 2 = 160 \text{ m}$.

¹⁷⁷ There are 500 mA fuses on the board respectively.

¹⁷⁸ Max. six 1826 / 1828 units.

¹⁷⁹ Printing will only be performed if and when the door in the ext. FBP is being opened. If the door is not opened until after all the alarms are reset, there will be no printing.

25 Power supply

Main power source

Normally the EBL512 control unit is powered by the built-in rectifier (230 V AC / 24 V DC $\pm 1\%$, 4.5 A).

Second power source

By loss of 230 V AC etc. the control unit is powered by a backup battery¹⁸⁰, i.e. two Sealed Lead-Acid batteries, 12 V, 24 – 60 Ah (see tables on page 161 and forward).

The batteries and the rectifier are connected to the **Charger board 1657¹⁸¹**, which handles the charging of the batteries, etc.

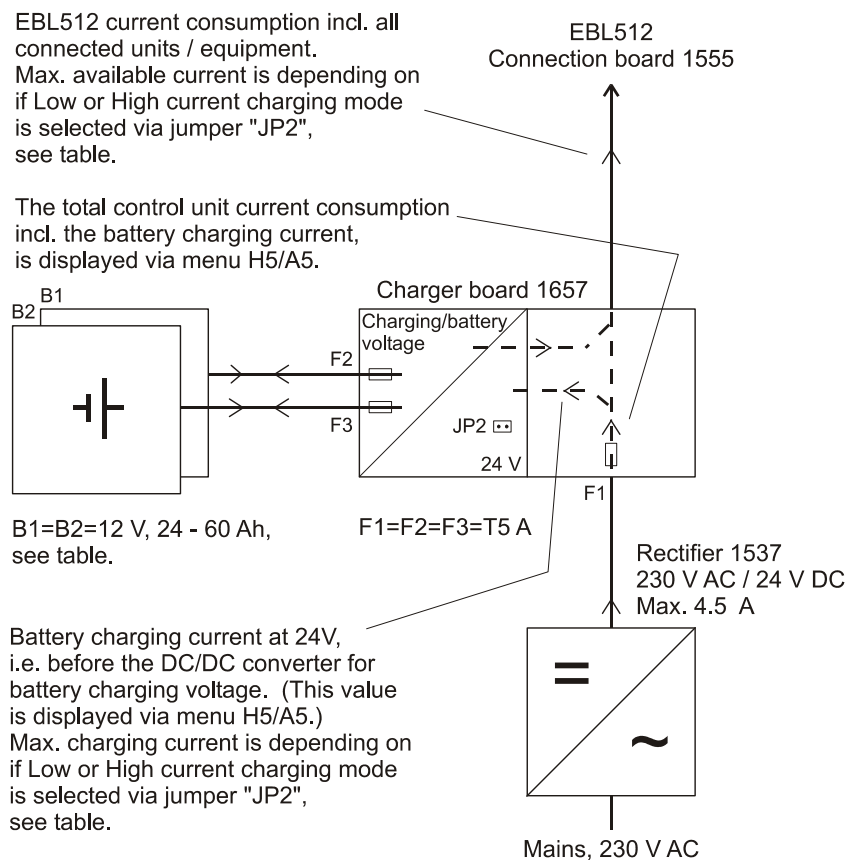

Figure 34. EBL512 power supply block diagram.
NOTE! The battery charging current value displayed via menu H5/A5 shall in "High current charging mode" be multiplied by two. Fuses F2 & F3: Ceramic.

EBL512 is a very flexible system, i.e. number of and types of loop units, number of and types of expansion boards, ext. FBPs, ext. equipment, etc. can vary from one control unit to another.

¹⁸⁰ **NOTE!** The batteries (2 x 12 V) are not included in the Control unit type no. 1548, 1549 & 1550. Batteries with the same physical size but with different capacities are available on the market (e.g. 24 / 27 Ah).

¹⁸¹ The former Charger board for EBL512 had the type no. 1557.

25.1 Charger functions

According to EN54-4, section 5.3.1 b): *The charger shall be designed and rated so that a battery discharged to its final voltage can be recharged to at least 80% of its rated capacity within 24 hours and to its rated capacity within another 48 hours.*

25.1.1 Low and High current charging modes

If the EN54-4 section is to be fulfilled, the **Low** or **High**¹⁸² current charging mode has to be selected depending on the wanted battery capacity and/or the wanted EBL512 current consumption¹⁸³, see the following table:

	Jumper "JP2"	Battery Capacity (Ah) ¹⁸⁴	EBL512 Current consumption (A) ¹⁸³
Low current charging mode	Open	≤ 27 ¹⁸⁵	≤ 2.2
High current charging mode	Shunted	≤ 60	≤ 0.85

(A high battery charging current results in a low EBL512 current consumption and vice versa.). The jumper "JP2" is situated on the charger board 1657.

25.1.2 Battery charging functions:

Battery charging is performed in two steps:

1. **Constant current.** The charging current is constant (fixed)¹⁸⁴ until the battery / charging voltage reaches 15 V.
2. **Constant voltage.** The charging voltage is reduced from 15 to 13.5-13.8 V¹⁸⁶ and will be constant (fixed) at this level until the batteries are fully charged.
 (The values in "step 2" are depending on the battery type, shape, temp. etc.)

When the battery is fully charged the stand-by "charging current" is 0-0.5 A (typical 0.1 A) and the "charging voltage" will stay constant (fixed) at the "step 2" level, until the batteries have been discharged and have to be charged again. A new charging cycle will then start.

¹⁸² **High** current charging mode shall normally be used only for batteries with a capacity ≥ 60 Ah

¹⁸³ The c.i.e. **incl.** connected ext. equipment but **excl.** the charging current.

¹⁸⁴ The is depending on if **Low** or **High** current charging mode is selected, i.e. 1.2 - 1.5 A (typical value **1.3** A) and 2.0 - 2.4 A (typical value **2.2** A) respectively. (Very close to the end of the charging cycle, when 15 V charging voltage is reached, the charging current will be 1.1 and 1.8 A respectively.)

¹⁸⁵ In fact up to 34 Ah if such a battery is available.

¹⁸⁶ The actual voltage is depending on the battery type, shape, temp. etc.

The duration of "step 1" and "step 2" respectively is depending on the battery shape when the charging started.

25.1.3 Security functions:

- The battery charging will be turned off if the current from the Rectifier 1537 to the Charger board 1657 exceeds 4.5 A. The battery charging will remain turned off as long as the EBL512 current consumption exceeds 0.85 and 2.2 A respectively (depending on charging mode). Fault message, see below.
- In order to not damage the batteries, the voltage output will be switched off at approx. 15 V. This only happens in case of no main power source (230 V AC), i.e. when the backup batteries are used as power source.
- If the battery voltage is below 10 V (5 V per battery), the battery charging will be turned off. (The batteries are damaged and have to be changed.)
- In case of no battery charging (turned off or no mains) and after a time delay of 1-300 minutes (programmable in Win512 but max. 30 min. according to the EN54-2 standard), the following fault message will be shown:

FAULT: Mains, control unit xx Date: MM-DD Time: HH:MM
--

25.2 Current consumption calculations

For each control unit, in order to get a current consumption overview so that the rectifier will not be overloaded and to check / calculate the required battery capacity, the total EBL512 current consumption (excl. battery charging current) have to be calculated. **NOTE!** There is no battery charging during fire alarm.

Use the values in chapter "Current consumption", page 152, to calculate the following current consumptions:

- I^{CN} = current consumption for the control unit¹⁸⁷ in normal state.
- I^{RN} = current consumption for all other equipment¹⁸⁸ in normal state.
- I^{CA} = current consumption for the control unit¹⁸⁷ in alarm state.
- I^{RA} = current consumption for all other equipment¹⁸⁹ in alarm state.

¹⁸⁷ Including the COM loop units but excl. the battery charging current.

¹⁸⁸ External equipment connected to the control unit (e.g. ext. FBPs, door release magnets, relays, routing equipment, etc.).

¹⁸⁹ External equipment connected to the control unit (e.g. ext. FBPs, sounders, relays, routing equipment, etc.).

The total EBL512 current consumption in **Normal** (quiescent) **state**:
 $I^{TN} = I^{CN} + I^{RN}$

The total EBL512 current consumption in **Alarm** (activated) **state**:
 $I^{TA} = I^{CA} + I^{RA}$

Comments regarding (I^{TN}):

I^{TN} shall be ≤ 0.85 A or ≤ 2.2 A respectively depending on if **High** or **Low** current charging mode is selected, see table on page 158.

I^{TN} shall be ≤ 0.8 A if the built-in battery is a 24 Ah battery, because this results (theoretically) in 30 hours battery backup time.

I^{TN} shall be ≤ 0.9 A if the built-in battery is a 27 Ah battery, because this results (theoretically) in 30 hours battery backup time.

NOTE!

In **High** current charging mode I^{TN} is max. **0.85 A**.

In **Low** current charging mode I^{TN} is max. 2.2 A but if the required battery backup time is 30 hours I^{TN} can be max. **0.85 A**.

Comments regarding (I^{TA}):

I^{TA} has to be ≤ 4 A. (The battery charging will be turned off in conjunction with a fire alarm in the system.)

For the total EBL512 current consumption in relation to **backup time**, see tables in chapter "Battery (second power source)", page 160.

25.3 Rectifier (main power source)

The rectifier (1537) technical data is 230 V AC / 24 V DC, 4.5 A, i.e. **the total current consumption incl. max. battery charging current must not at any time exceed 4.5 A**. Allowed input voltage is 176-264 V AC. The output voltage is 24 V with a tolerance of $\pm 1\%$.¹⁹⁰

25.4 Battery (second power source)

Only batteries with a specified "Final voltage" of 10.5 V must be used. Find out the required battery backup time, according to national regulations / customer demands, in normal state and in alarm state.

Calculate the battery capacity required in normal state (Q^N) and the battery capacity required in alarm state (Q^A) respectively.

- Q^N (Ah) = I^{TN} (A) x battery backup time in normal state (h)
- Q^A (Ah) = I^{TA} (A) x battery backup time in alarm state (h)

The total battery capacity $Q = Q^N + Q^A$ (Ah)

Normally you shall round up the calculated capacity and add 10% to be on the safe side, because the battery voltage at the end of a discharging period is not the same as at the start. The following tables show the relation between the total current consumption in normal state (I^{TN}) and the backup time.

¹⁹⁰ The output voltage is factory set to 24 V. On the rectifier is a potentiometer for output voltage adjustment ($\pm 10\%$) available. **Do not use this potentiometer** unless the output voltage is not 24 V.

NOTE! The values are calculated and give you only a rough idea of the backup time.

A battery ≤ 24 (27) Ah¹⁹¹ can be placed inside the control unit and the **Low** current charging mode can be used.

A battery > 24 (27) Ah has to be placed outside the control unit and the **High** current charging mode has to be used (if EN54-4 shall be fulfilled).

NOTE! For external batteries is the following valid: Max. 3 m cable length (min. 4 mm²). National regulations have to be followed.

Built-in **24 Ah** batteries (**Low** current charging mode).

I^{TN} (A)	Backup time (hours)
2	12
1.5	16
1.0	24
0.8	30
0.6	40
0.4	60

Built-in **27 Ah** batteries with the same size¹⁹¹ as the 24 Ah batteries (**Low** current charging mode).

I^{TN} (A)	Backup time (hours:min)
2	13:30
1.5	18:00
1.0	27:00
0.9	30:00
0.8	33:45
0.6	45:00
0.4	67:30

External **60 Ah** batteries (**High** current charging mode).

I^{TN} (A)	Backup time (hours)
0.85	70
0.8	75
0.6	100
0.4	150
0.2	300

25.5 Fuses

There are three fuses on the Charger board 1657 as follows:

F1 = T5A. +24 V DC from the rectifier (1537).

F2 = T5 A Ceramic. + to/from battery no. 1.

¹⁹¹ The battery's physical size is 175 x 165 x 125 mm.

F3 = T5 A Ceramic. + to/from battery no. 2.

25.6 Form / Table of current consumption

Some national regulations require different forms / tables regarding current consumption, to be filled-in. In such a case an ampere meter shall be used to read a true value instead of a calculated current consumption.

A tip: Remove the battery fuses "F2" and "F3" on the Charger board 1657 and use e.g. a "clamp current meter" on one of the wires between the rectifier and the Charger board 1657, to read the true total control unit current consumption (i.e. excl. the battery charging current).

or

Turn off the main power source (230 V AC) and use e.g. a "clamp current meter" on one of the wires between one of the batteries and the Charger board 1657, to read the true total control unit current consumption.

An approx. value is displayed via menu H5/A5.

A fault will be generated:

FAULT: Battery not connected CU xx

Acknowledge the fault.

Restore the fuses (the fault is corrected).

26 S/W versions

Due to continual development and improvement, different S/W versions can be found.

Different S/W versions can be found on different markets.

The S/W versions listed below were the valid ones when this document was written (the date of this document or date of revision).

S/W for:	Latest version	Required version
1548 / 1549 / 1550; EBL512	2.5 ¹⁹²	2.5
1580; 8 zones expansion board	3.0	2.1
1581; 8 relays expansion board	3.0	1.2
1582; Ext. FBP interface board	3.0	3.0
1583; German FBP interface board	3.0	3.0
1584; Autronica interface board	3.3	3.3
1587; Ext. FBP / DU interface board	3.1	3.1
1590; TLON connection board	1.2	1.1
2235 / 2236 (2237 / 2238); Display unit	2.30 (2.30)	2.21 (2.30)
2262 / 2263; Addr. 4 outputs unit	3.22	3.1
2425 / 2426; Ext. FBP	2.03	2.03
2427; Ext. FBP	2.04	2.04
2428; Ext. Presentation Display	2.05	2.05
1728; Ext. Presentation unit (EPU)	1.2	1.1
1735 / 1736; Alert Annunciation unit (AAU)	1.2	1.1
1826 / 1828; Ext. Fire Brigade Panel (FBP)	1.2	1.1
Win512	2.5 ¹⁹²	2.5
TLON Manager	1.2	1.12
TLON DDE Server	2.5	2.5
1588 Web-server ¹⁹³	2.5	2.5
1598 Web-server II ¹⁹⁴	2.5	2.5
4582 I/O Matrix board	1.0	1.0

¹⁹² **NOTE!** The latest version can vary depending on the market / country.

¹⁹³ The Web server is used in other systems as well. The web-server S/W will be downloaded via the web-server configuration tool. For system EBL512 it is "Web512 Config tool", version = EBL512 version.

¹⁹⁴ The Web server is used in other systems as well. The web-server S/W will be downloaded via a PC program called "Web512 II Config tool 2.x.x". **NOTE!** The Config Tool version and the EBL512 S/W version have to be the same.

27 Technical data

Voltage

Primary (V AC): **230** (176-264)

System (V DC): **24**¹⁹⁵

Current consumption (A)

Quiescent / active: Depending on type (1548-1550), etc. See chapter "Current consumption", page 152

Ambient temperature (°C)

Operating: 0 to +40

Storage: -40 to +70

Ambient humidity (%RH)

max. 90, non condensing

Ingress protection rating

IP 22 (estimated)

Size H x W x D (mm)

610 x 400 x 175. See also drawing 512-11

Weight (kg)

1548: 17.6

1549: 18

1550: 17.4

Colour

Metal cabinet: light grey (NCS S 1500-N / PMS Cool Gray 2)

Approvals

Conforms to EN 54-2 and EN 54-4.

The front conforms to SS3654

¹⁹⁵ The rated output voltage is 24 V DC \pm 1% for the main power source (rectifier). Max. ripple 500 mVp-p. The rated output voltage for the second power source (backup battery) is 20-27 V DC. **NOTE!** The voltage will, however, decrease to approx. 15 V when the output will be switched off in order not to damage the battery.

28 Limitations

See also "Control Unit / TLON Network", page 20.

28.1 User definable texts

At least 617¹⁹⁶ "User definable texts" can be programmed per c.i.e.
The texts are to be distributed amongst the following:

- Alarm points (Zone / Address)
- Alarm Zones
- Interlocking Combinations
- Ext. faults

At least 617 "User definable texts" can be programmed per 1728, 1735, 1736, 1826 and 1828 unit.

28.2 C.i.e. / System

Max. number of "items" per c.i.e. and per system respectively (when nothing is specified for the c.i.e. the same is valid as for the system):

¹⁹⁶ **NOTE!** The 90 most common words will be stored in a special list, which gives more memory available for the rest of the texts, i.e. the **exact** number of texts is impossible to specify.

Item	C.i.e.	System
General fire alarm inputs	250	
External fault inputs		50
Programmable outputs (= control expressions) ¹⁹⁷	200	
Interlocking Combinations	200	1000 ¹⁹⁸
Presentation numbers ¹⁹⁹ that can be presented in the display(s) in case of fire alarm	512	512
Presentation numbers ¹⁹⁹ that can be programmed	512	30 x 512 = 15 360
Zones ²⁰⁰ that can be programmed	512	512 ²⁰¹
Faults		200
Disabled zones		512
Disabled alarm points (zone/address) + Disabled COM loops		200 ²⁰²
Disabled outputs		200 ²⁰³
Disabled interlocking outputs		200 ²⁰⁴
Sensors activating SERVICE signal		100
Max. number of AAF zones (Max. 5 detectors per AAF zone.) ²⁰⁵	100	

¹⁹⁷ Approx. 1000 trigger conditions can be used in these control expressions.

¹⁹⁸ Max. 100 user definable texts can be displayed "at the same time".

¹⁹⁹ Presentation number is a ZONE only or ZONE – ADDRESS.

²⁰⁰ Any zone number between 001 and 999 can be used for the 512 zones.

²⁰¹ Theoretically 999 zones can be programmed but according to EN54-2 it shall be possible to present all "fire alarms" in the display, i.e. max. 512.

²⁰² Zone/address disabled via time channel not included.

²⁰³ Control OFF (menu H2/B8) and Alarm device OFF (menu H2/B9) not included.

²⁰⁴ Interlocking outputs disabled via "000/00" in menu H9/C4 not included.

²⁰⁵ Used in conjunction with the AAF Control, which is available on the Australian market only.

29 National regulations

When planning a fire alarm installation, national regulations, customer demands, etc. have to be followed.

EBL512 is very flexible. Many functions / facilities are built-in the system, e.g. in the S/W and Win512.

When downloading S/W and SSD, different settings, conventions, languages, etc. can be set to fulfil national regulations.

30 Drawings / connection diagrams

All dimensions quoted are approximate only and subject to change without notice, as are other technical features and data, resulting from continual development and improvement.

31 **Revision history**

This page has deliberately been left blank.

